



وحداتي

وحداتي
المستوى الأول

يحتوي الكتاب على موضوعات
وحدات رياض الأطفال

إعداد: ربيعة خلفان الشاعر السويدي

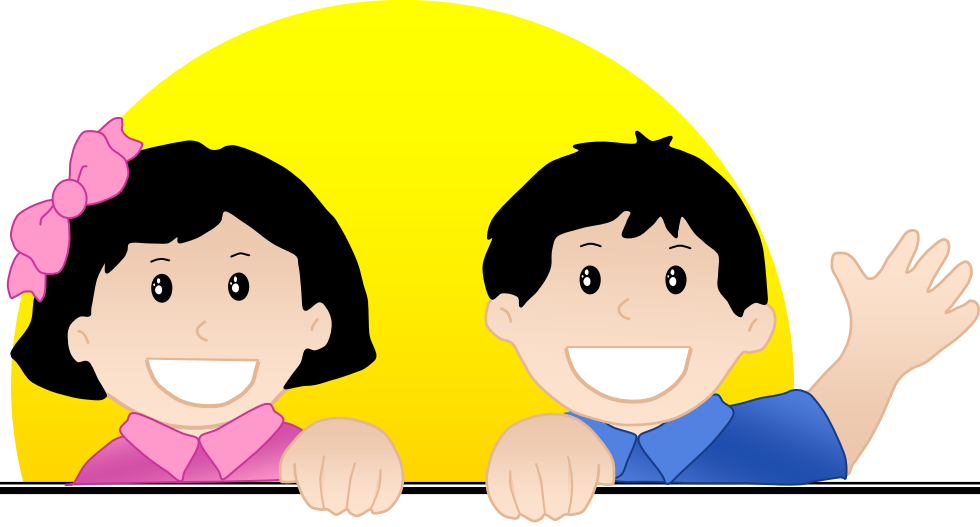

الاسم : _____
المدرسة : _____
المستوى الأول : _____ العام الدراسي : _____

الكتاب غير مخصص للبيع

نشر على الموقع الإلكتروني

www.e-portal.ae البوابة التعليمية

إعداد: رفيدة خلفان الشاعر السويدي

e-p@e-portal.ae

دبي - الإمارات العربية المتحدة 2011 م



وحداتي

المستوى الأول

- 3- وحدة أهلاً وسهلاً _____
- 8- وحدة أنا _____
- 17- وحدة العائلة _____
- 23- وحدة المسكن _____
- 29- وحدة رمضان _____
- 34- وحدة الملابس _____
- 42- وحدة اليوم الوطني _____
- 49- وحدة الطعام والشراب _____
- 55- وحدة الحيوانات _____
- 63- وحدة الصحراء _____
- 70- وحدة الحج _____
- 77- وحدة النباتات _____
- 82- وحدة الماء _____
- 87- وحدة المواصلات _____
- 93- وحدة السيرة النبوية _____
- 99- وحدة السياحة _____
- 104- وحدة الكتاب _____
- 110- وحدة البيئة _____
- 115- وحدة الفضاء _____
- 121- وحدة مع السلامة _____

وحدة

أهلاً وسهلاً



أهلاً وسهلاً



3

www.Cryp2Day.com

مذكرات جاهزة للطباعة

وحداتي

أخطط أفقي.

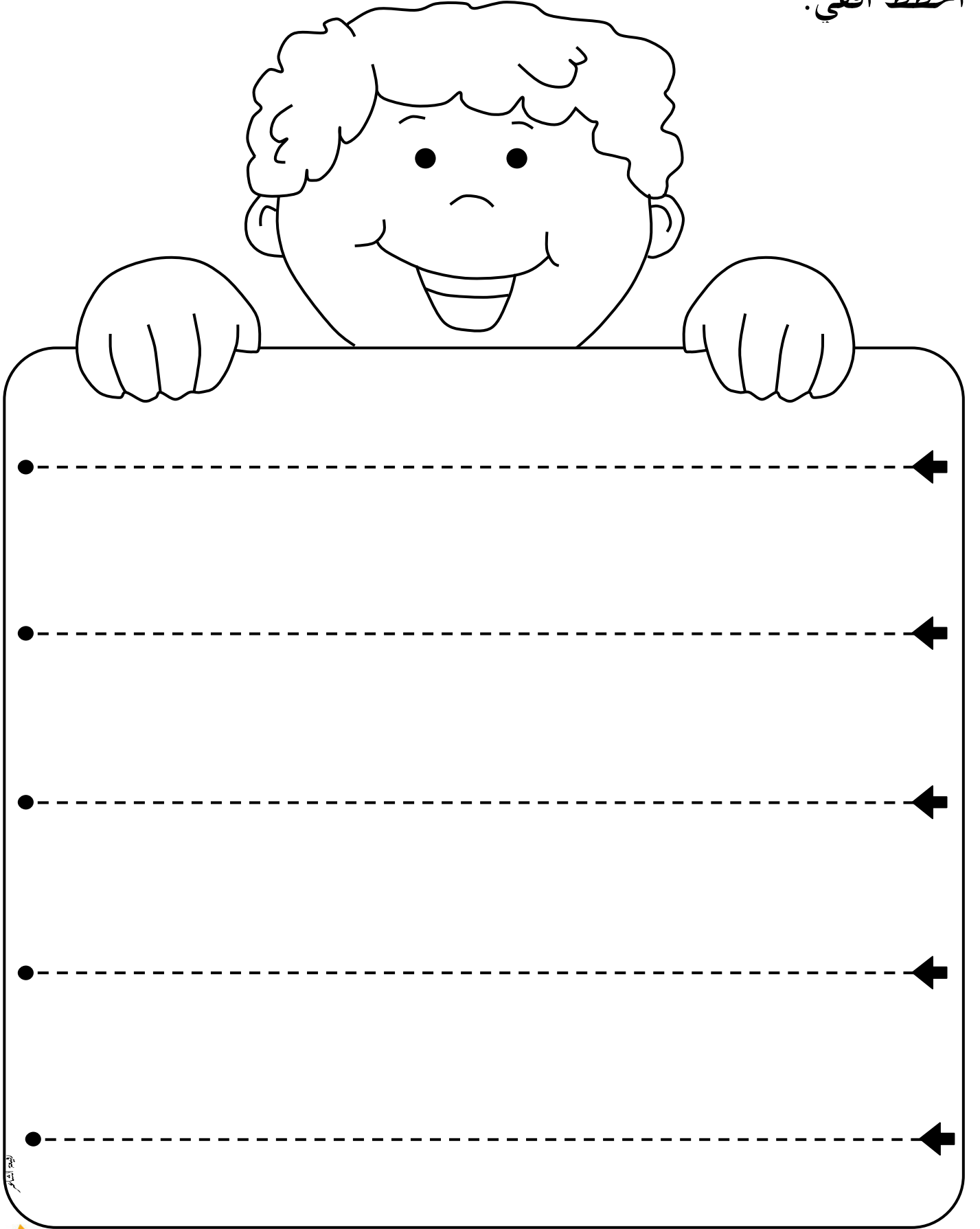

أخطط عمودي.

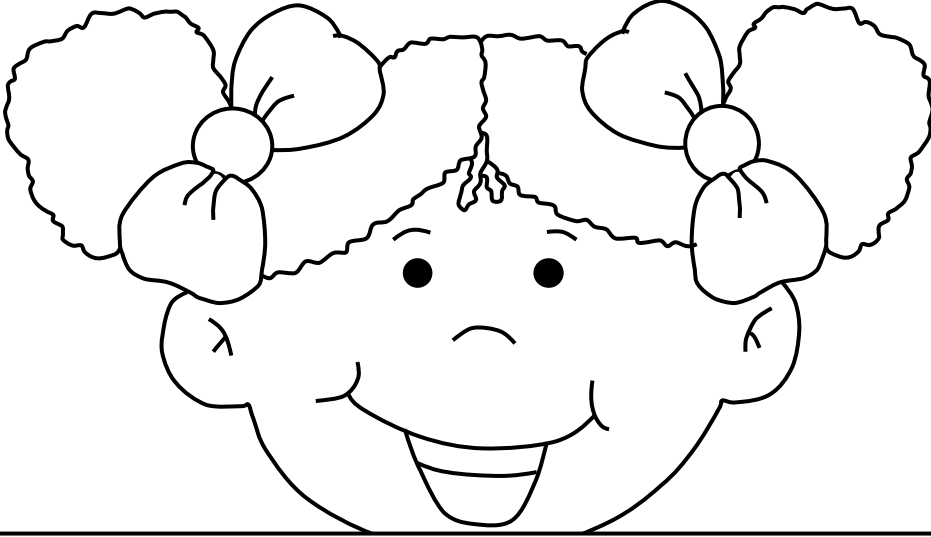

ماذا يوجد في صفّي؟ ألون.

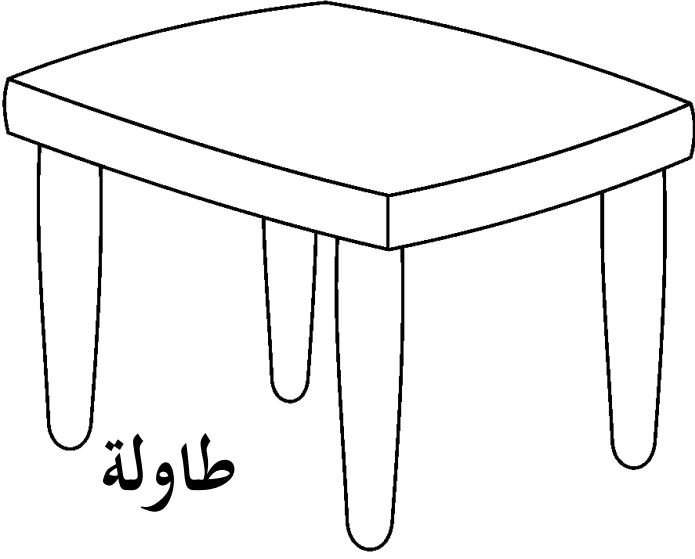

طاولة

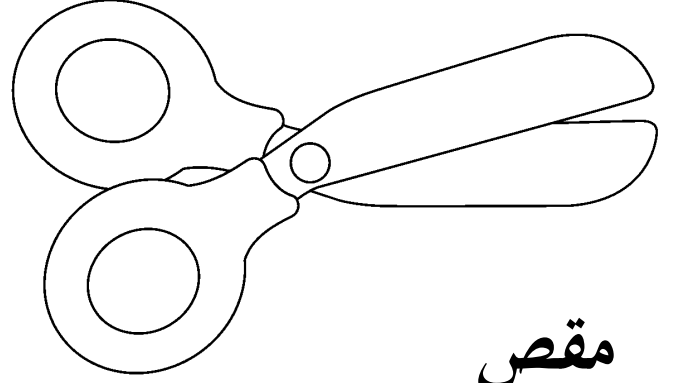

مقص

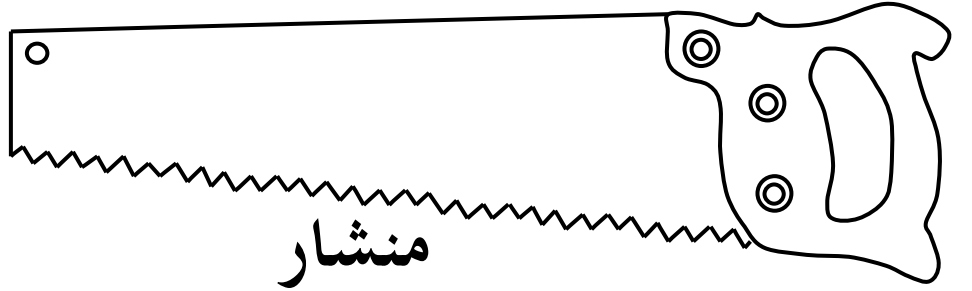

منشار

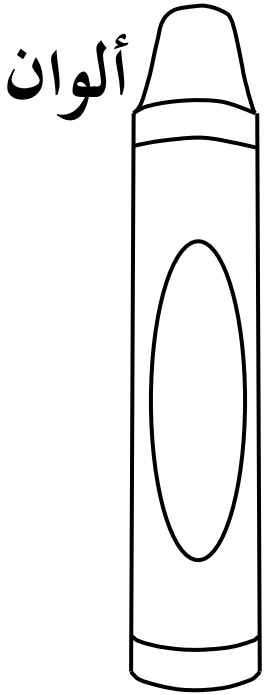

ألوان

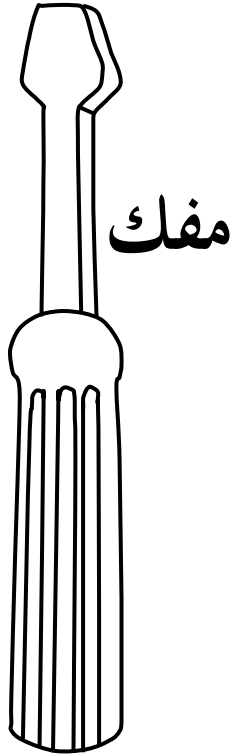

مفك

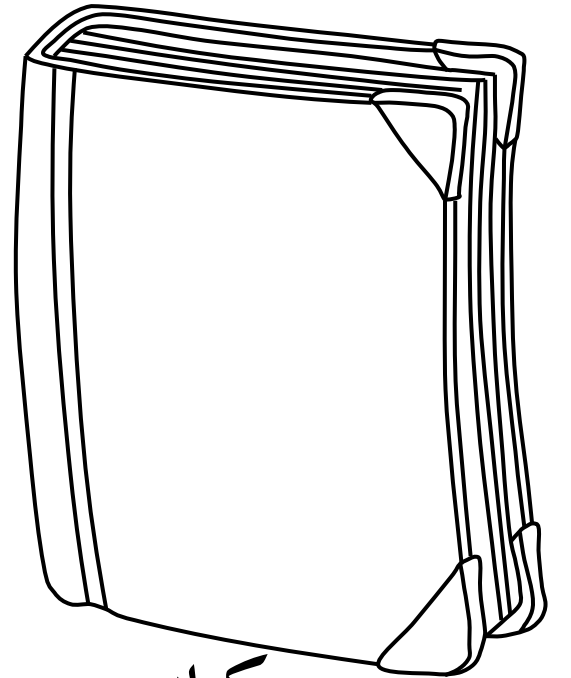

كتاب



ماذا يوجد في روضتي؟ ألون.

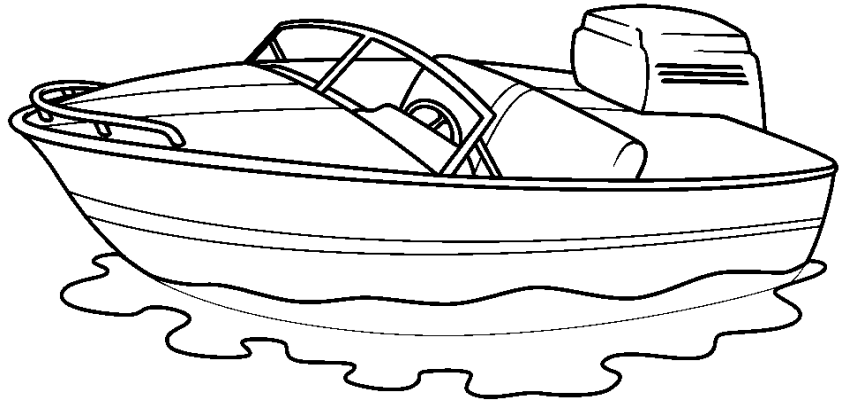
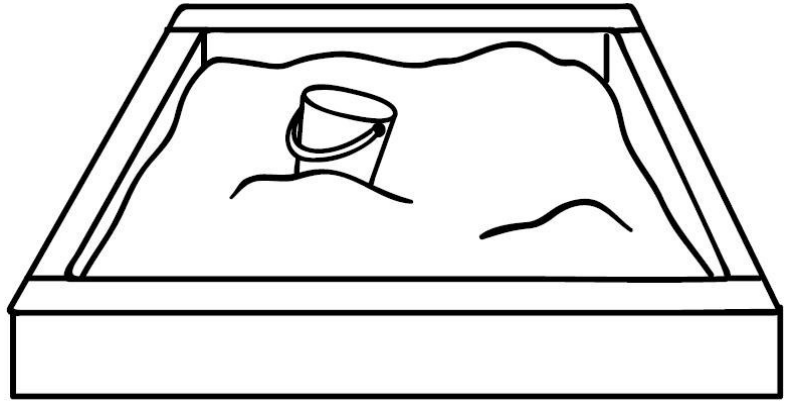
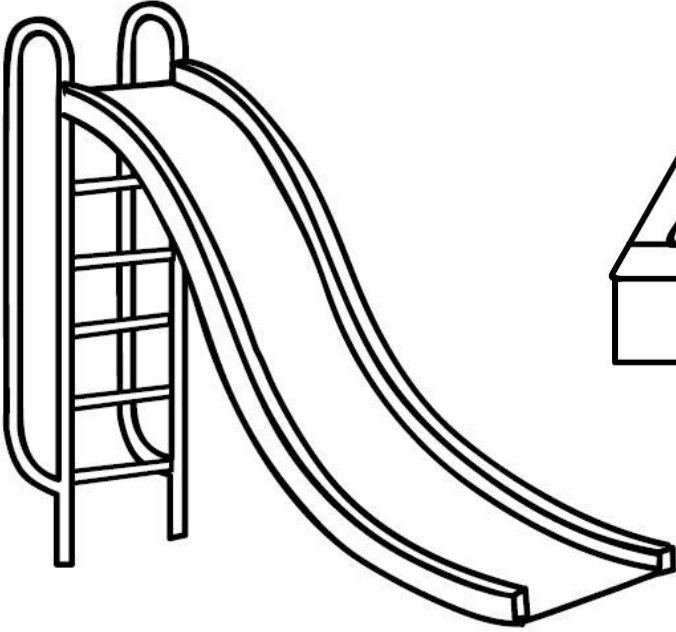
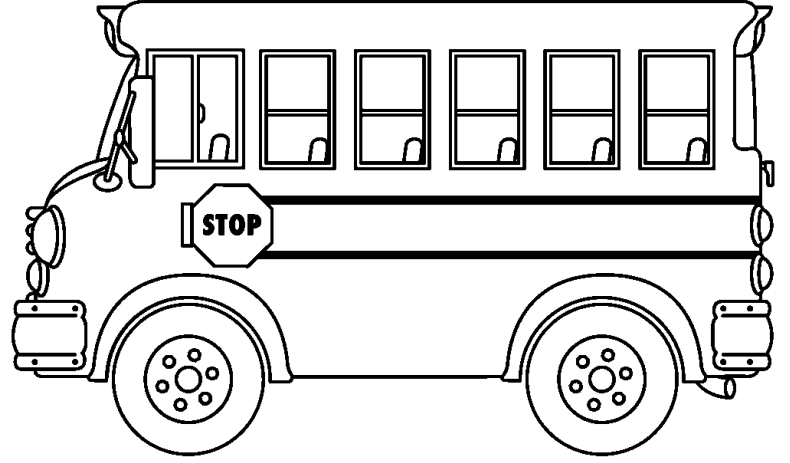
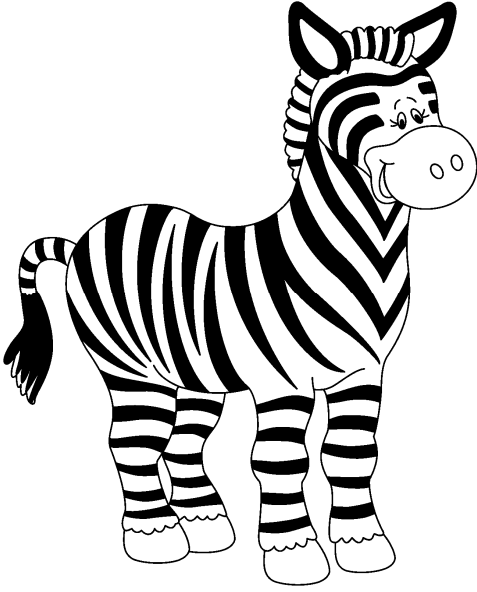

أهلاً وسهلاً



وحدة

أنا



أنا



8

www.Cryp2Day.com

مذكرات جاهزة للطباعة

وحداتي

من أنا ؟ ألون

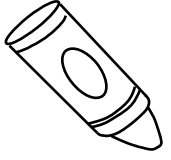

بنت



ولد



أنا

وحداتي

أجزاء جسمي تتحرك، أحوط ما يحركه الولد في الأفعال التالية (يد ، رجل).

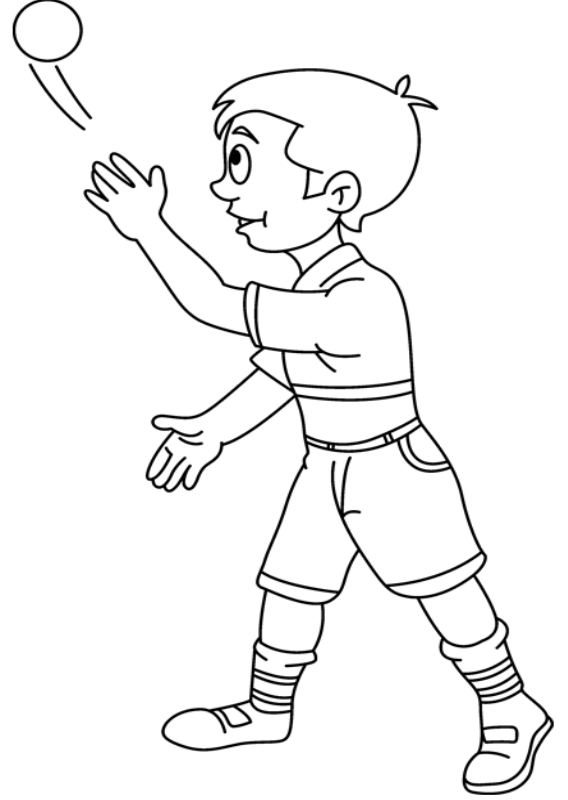

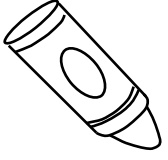

أنظف أسناني وأحافظ على نظافة جسمي.

أسناني
نظيفة



جسمي
نظيف

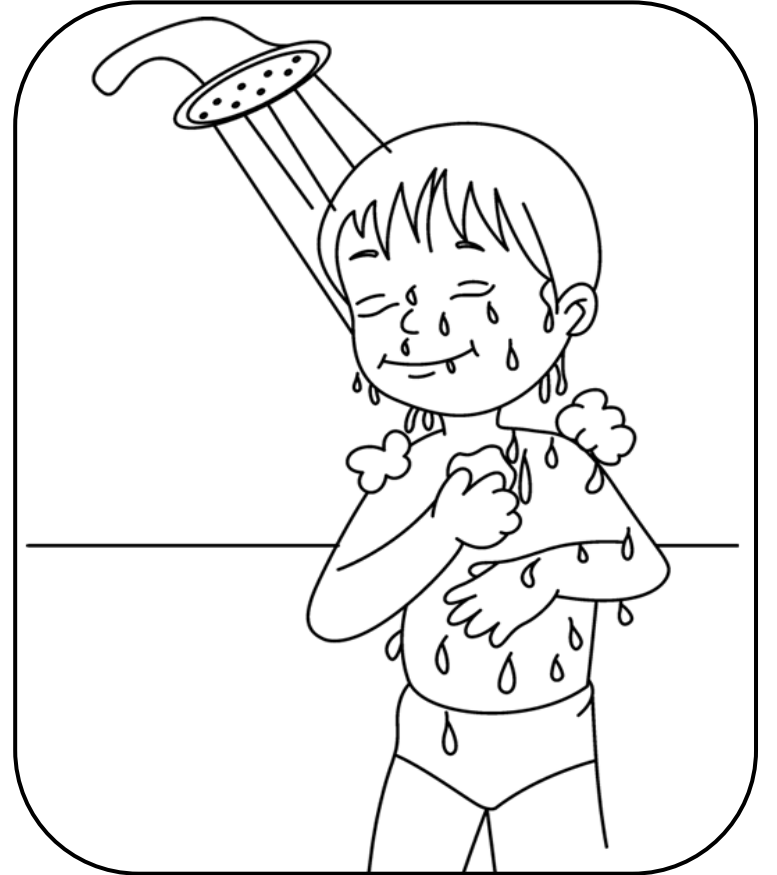

أنا لي حواس أصل الشيء بالحاسة المناسبة.

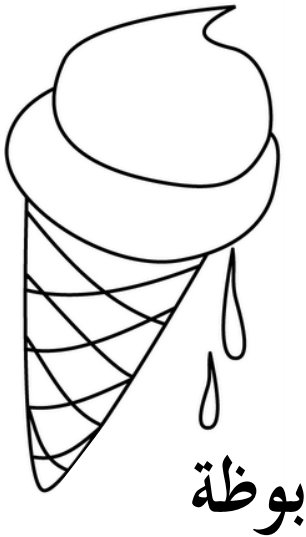
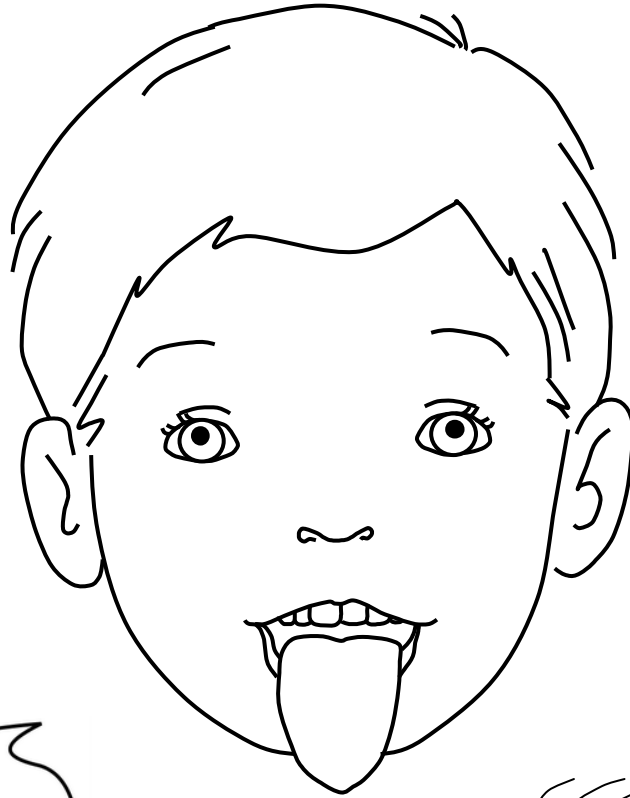
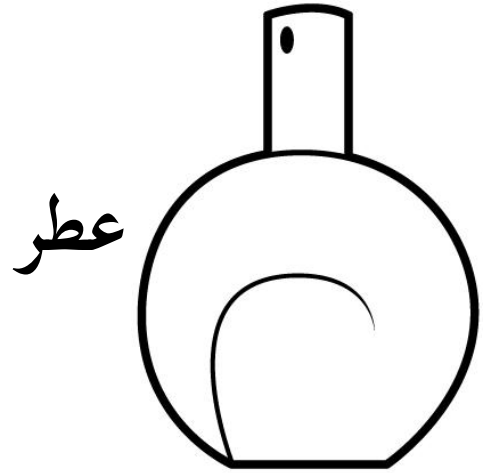

أنا

وحداتي

مشاعرنا مختلفة، مشاعرنا تتغير، أظابق وأصل.

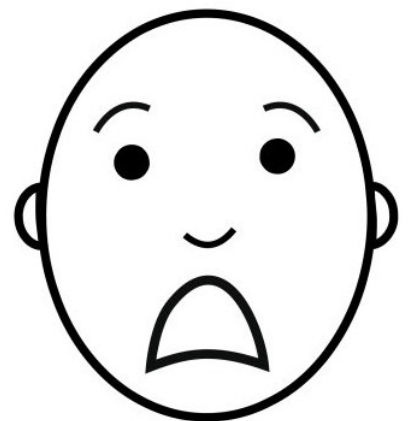
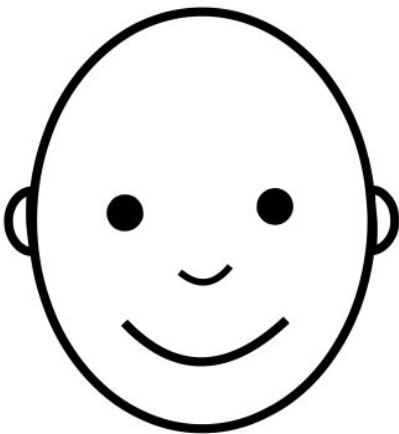
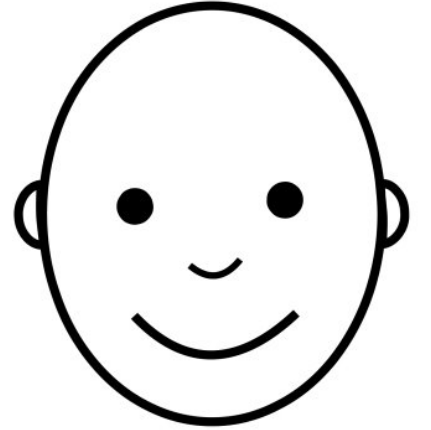
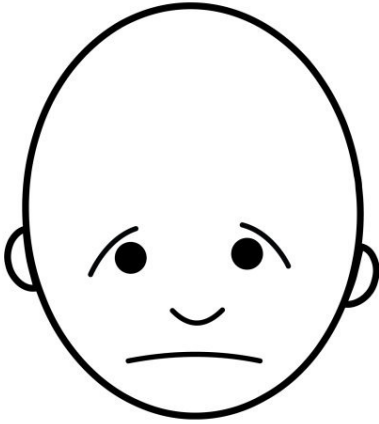
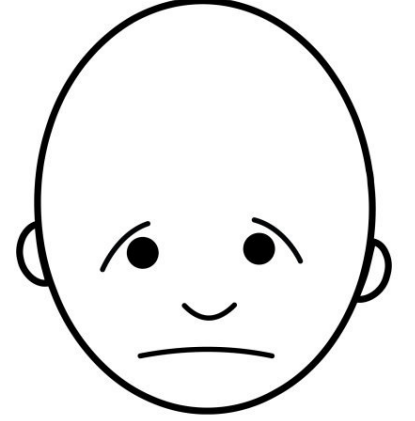
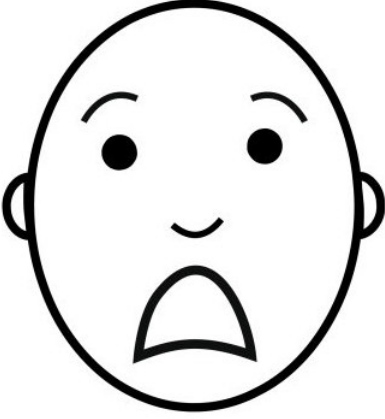

أرسم شكل الدائرة.

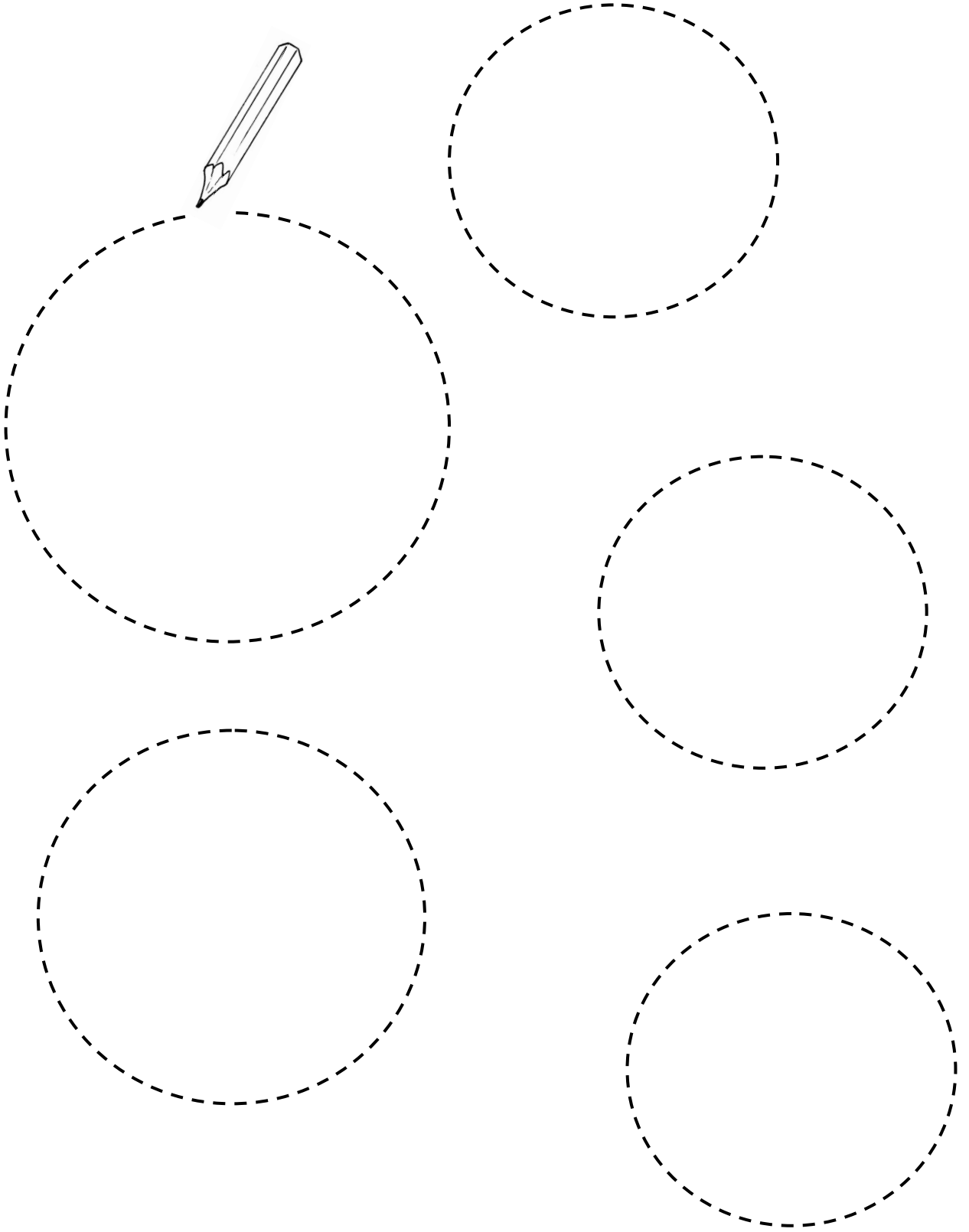

" طويل ، قصير " ألون ما حجمه طويل.

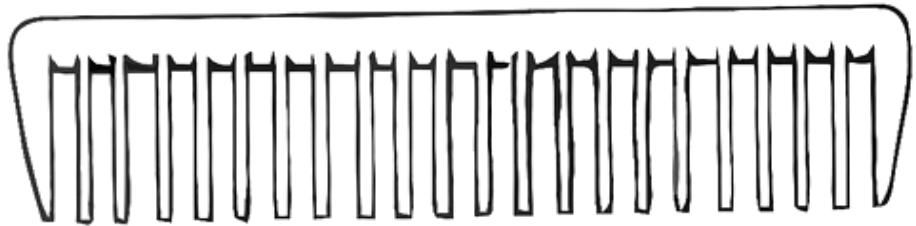
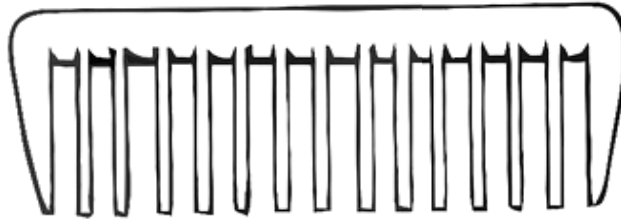
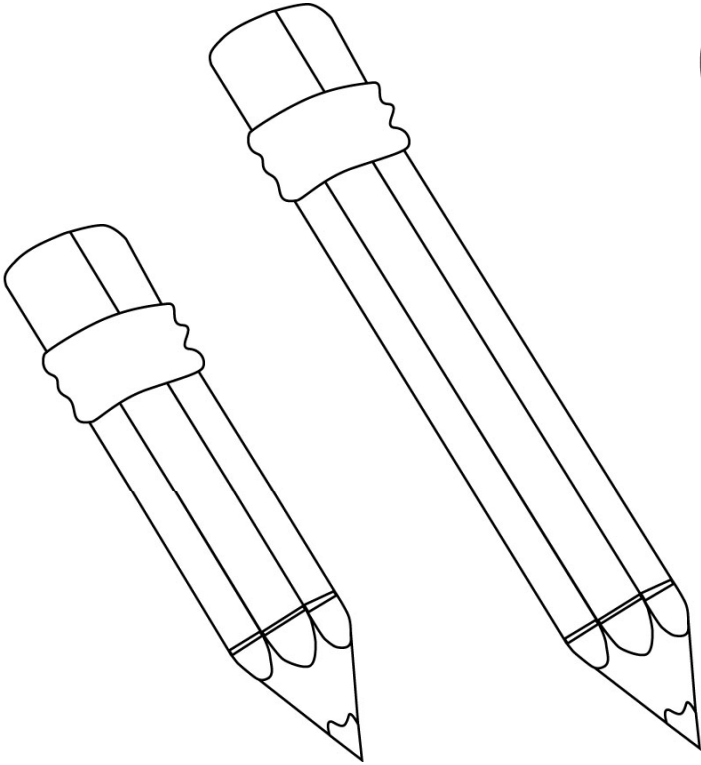
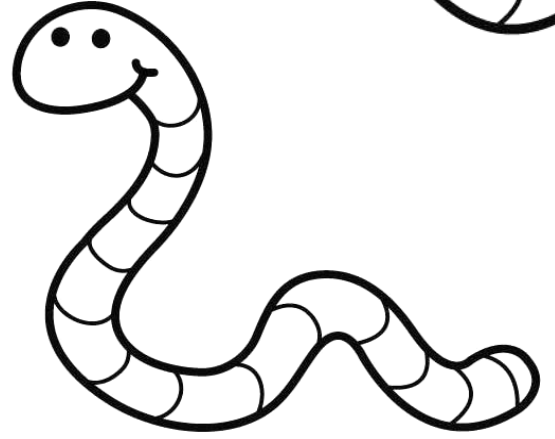
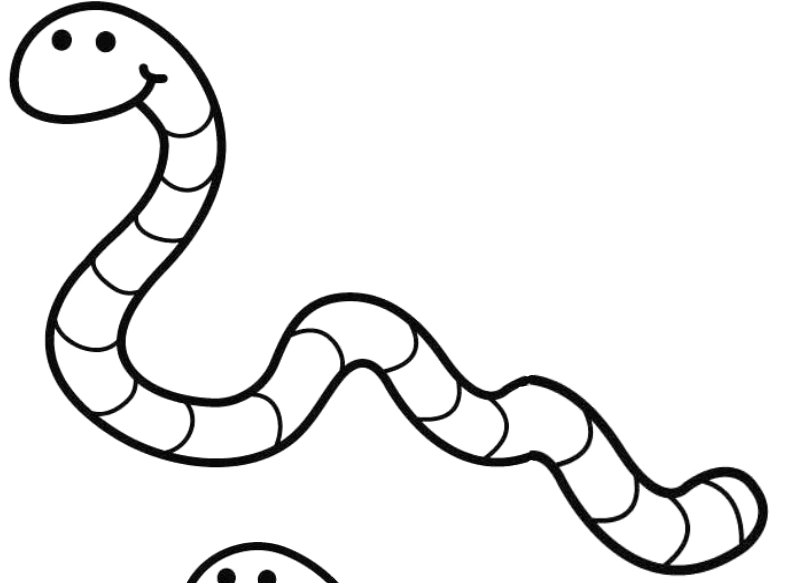

ألون ما شكله دائرة.

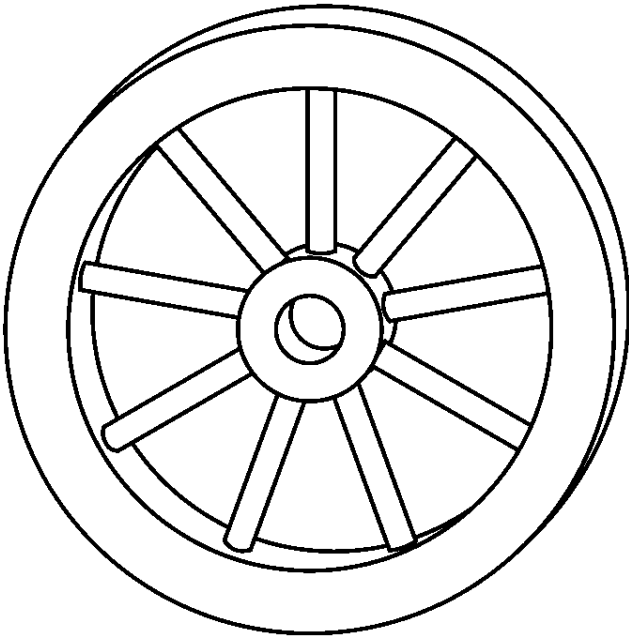
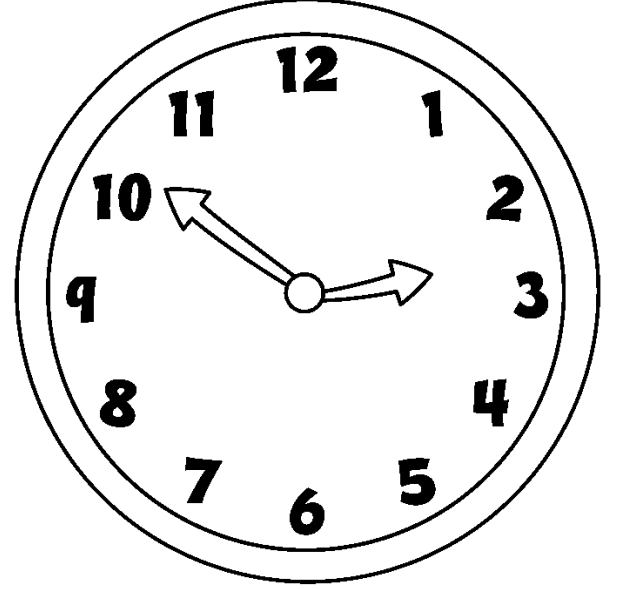
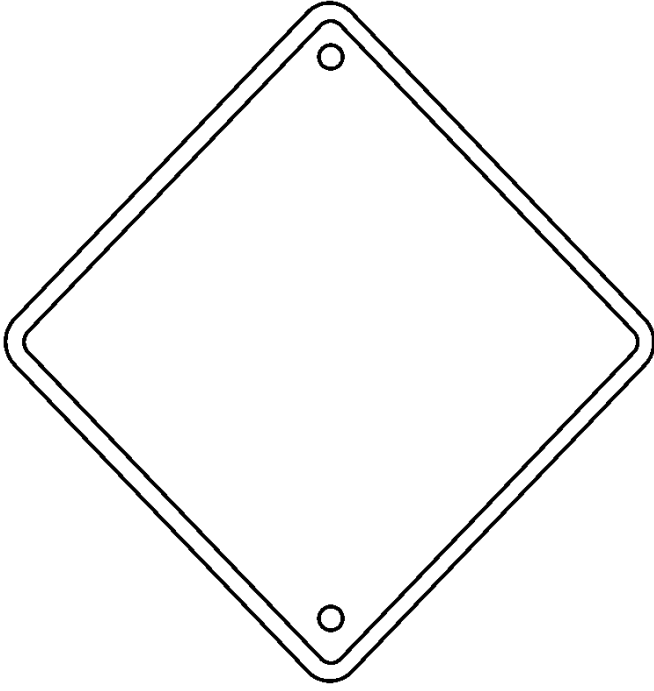



وحدة

العائلة



أفراد العائلة . أظابق وأصل.

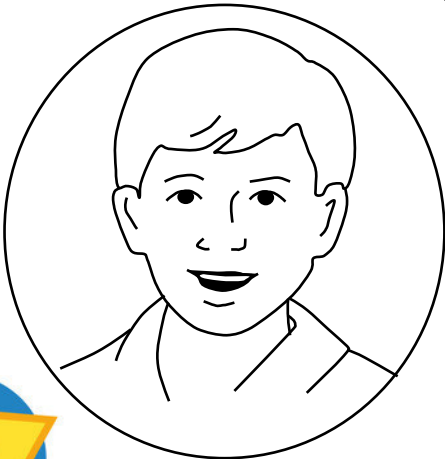
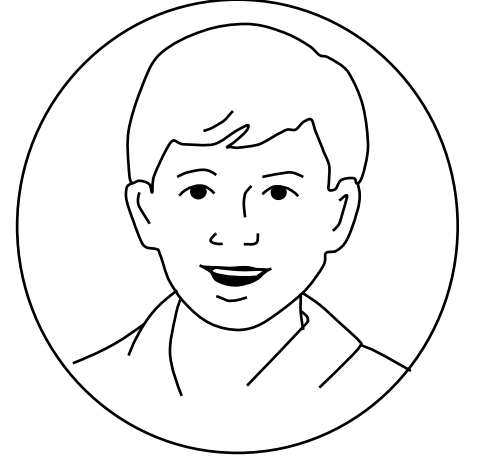
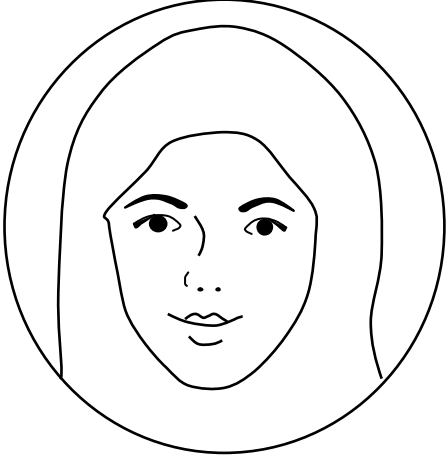
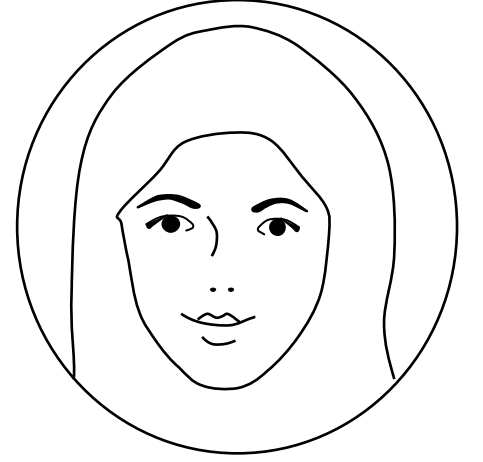
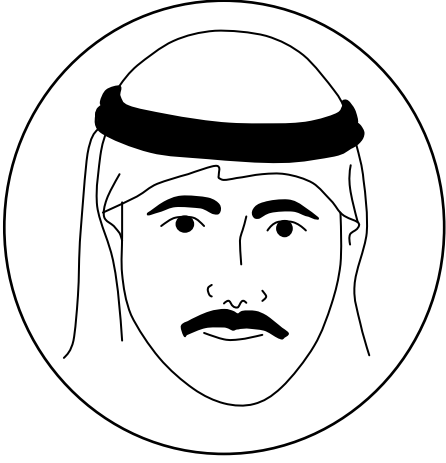

أصل الطفل الرضيع بحاجياته.

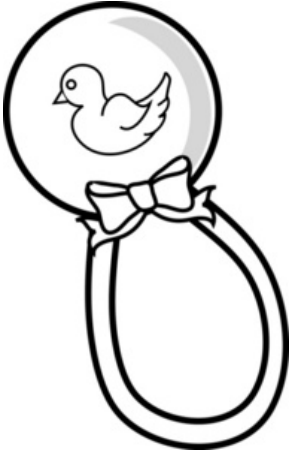
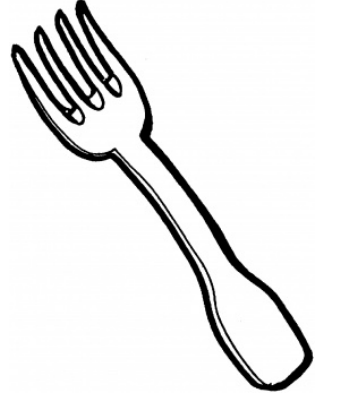
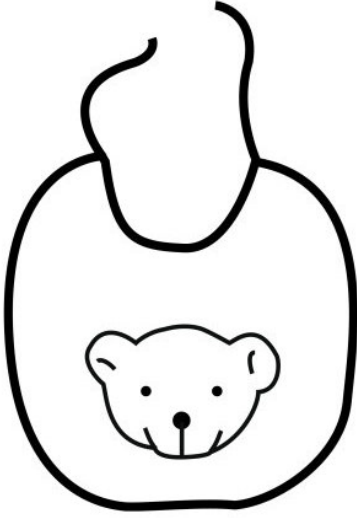
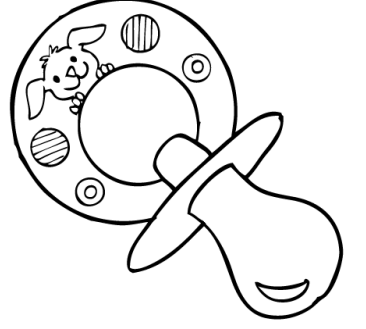
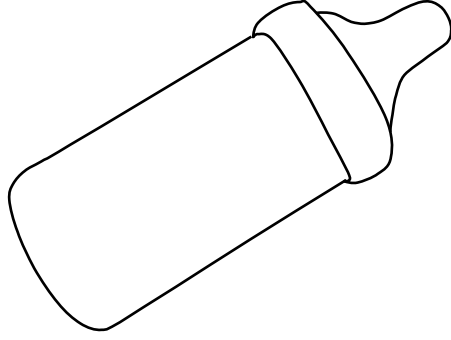
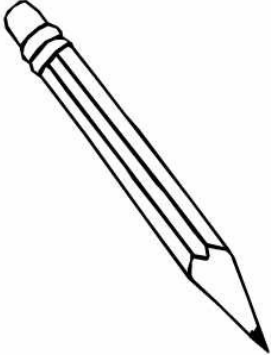

" كبير ، صغير " ألّون ما حجمه كبير .

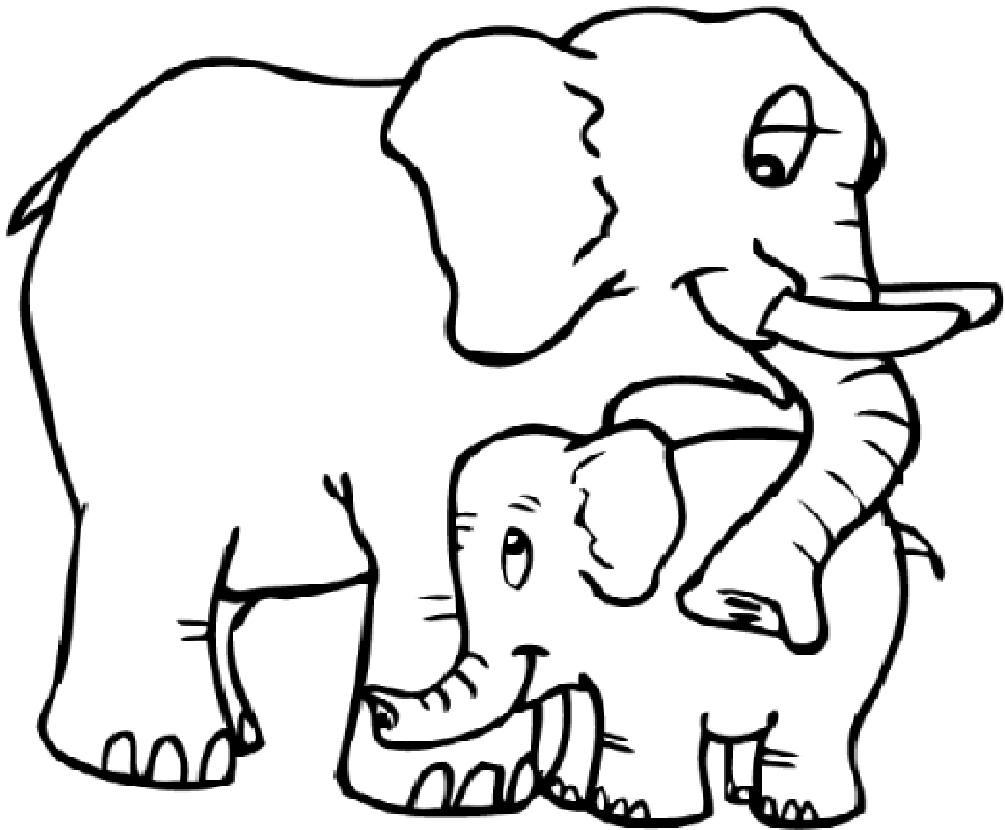

" فوق ، تحت " أرسم ○ على ما هو فوق . وأرسم × على ما هو تحت .

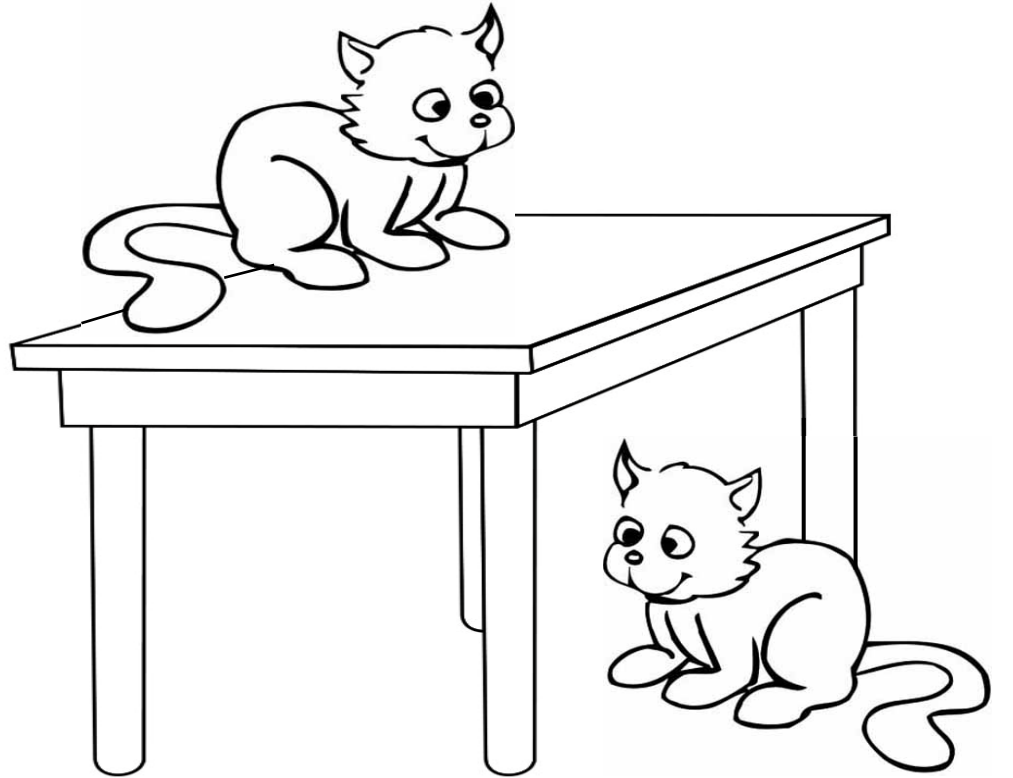
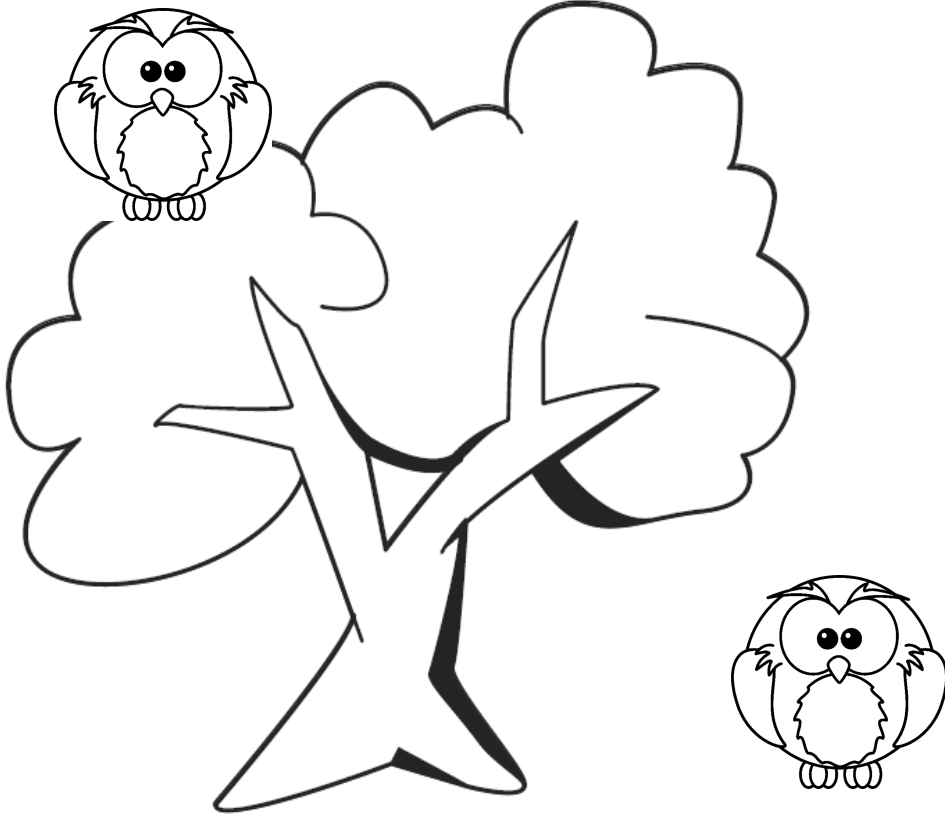

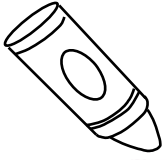

أمي و أبي





وحدة

المسكن



أتعرف على أنواع المساكن ، أقرأ وألون .

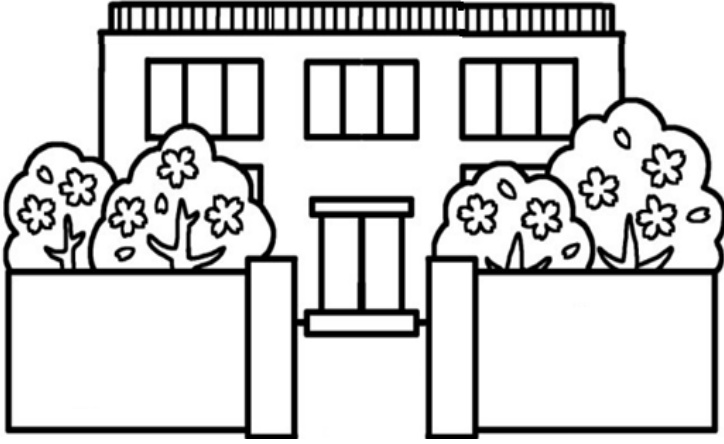

فيلا



خيمة

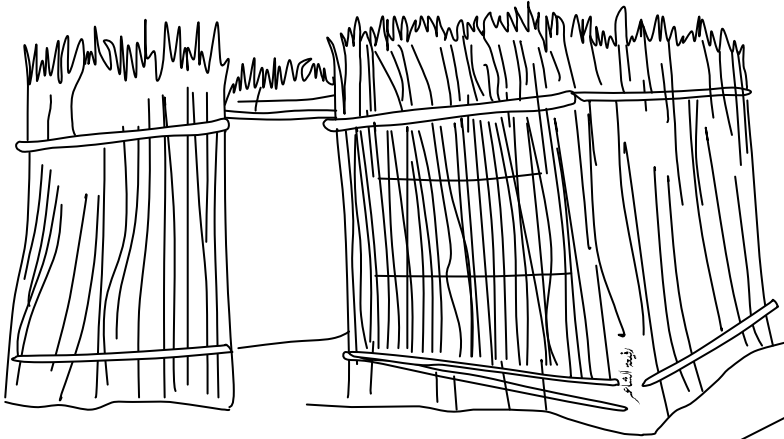

عريش

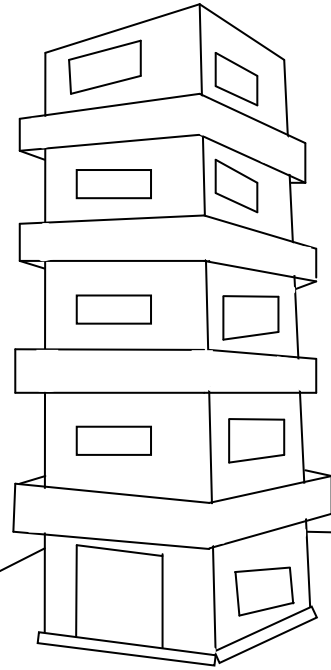

بناية



أصل الشخص للغرفة المناسبة.

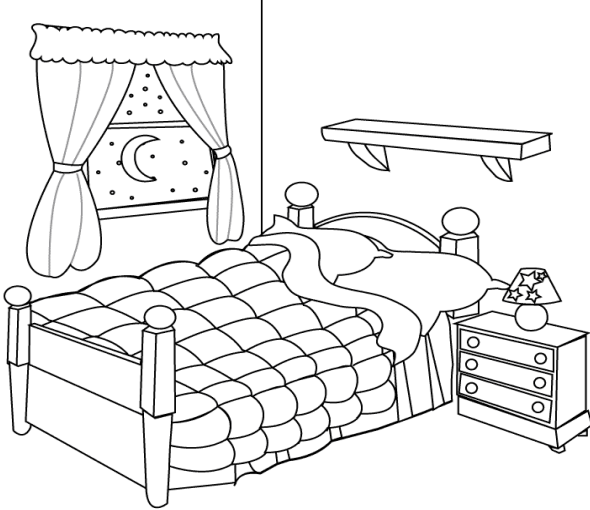
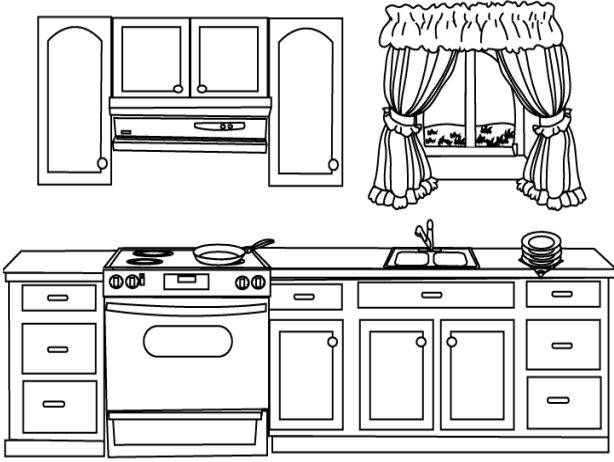

أبحث عن أدوات البناء وأحوظها.

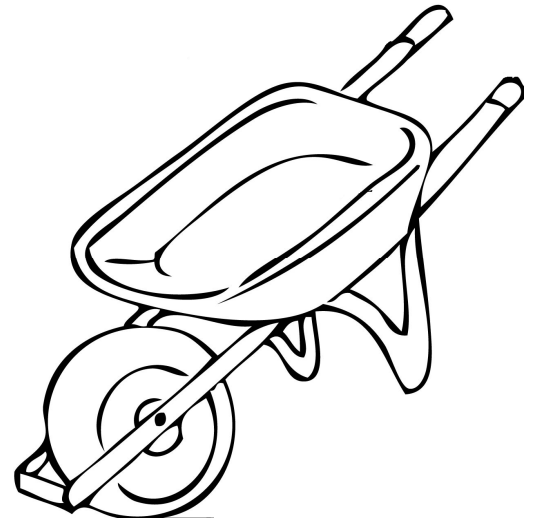
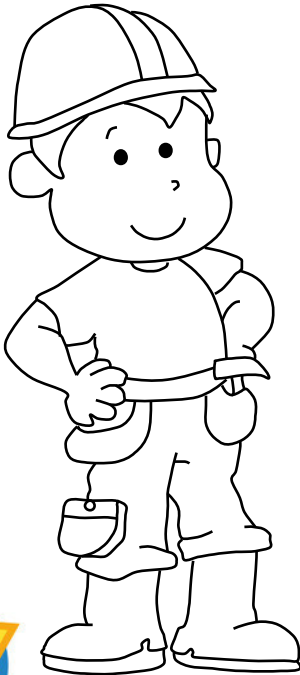
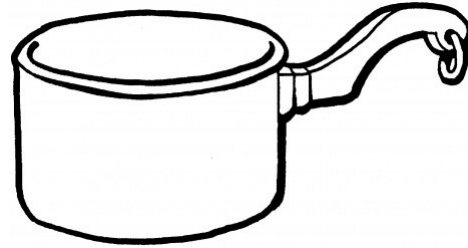
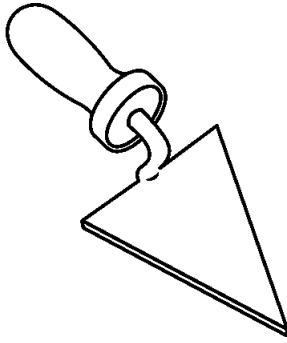
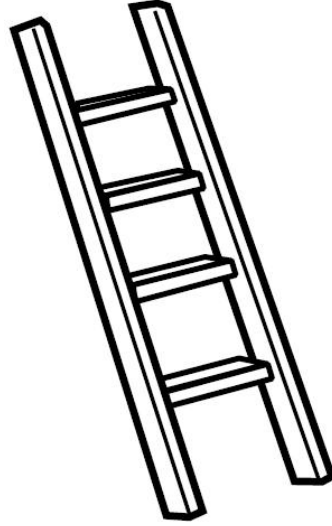
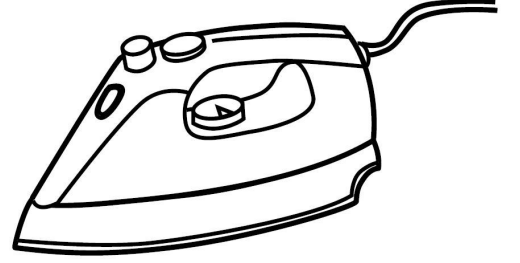
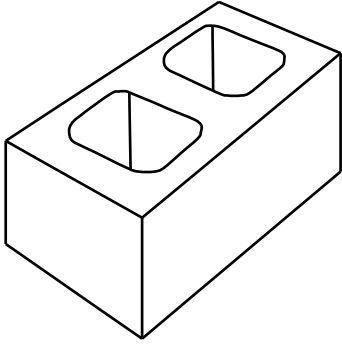

المسكن

وحداتي

أرسم علامة **X** على السلوك الخاطئ.

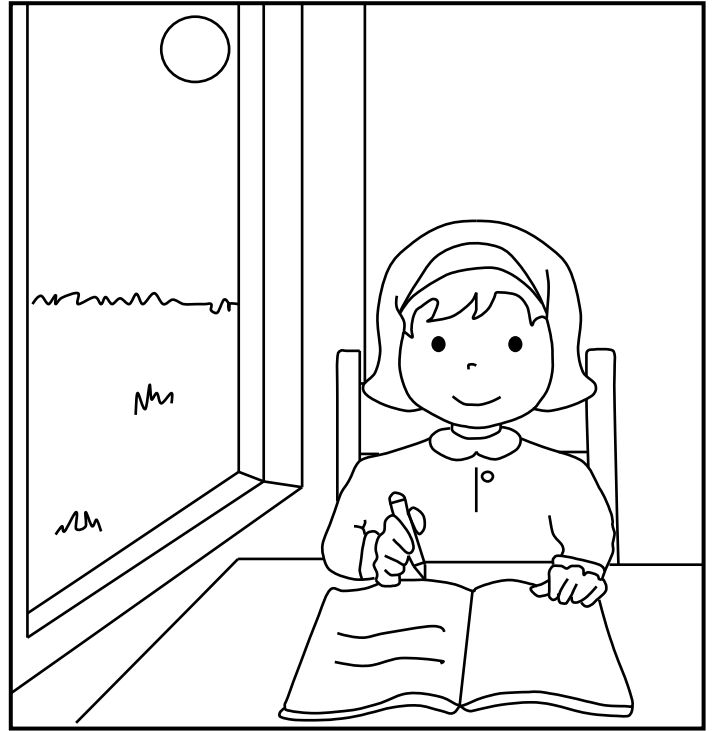
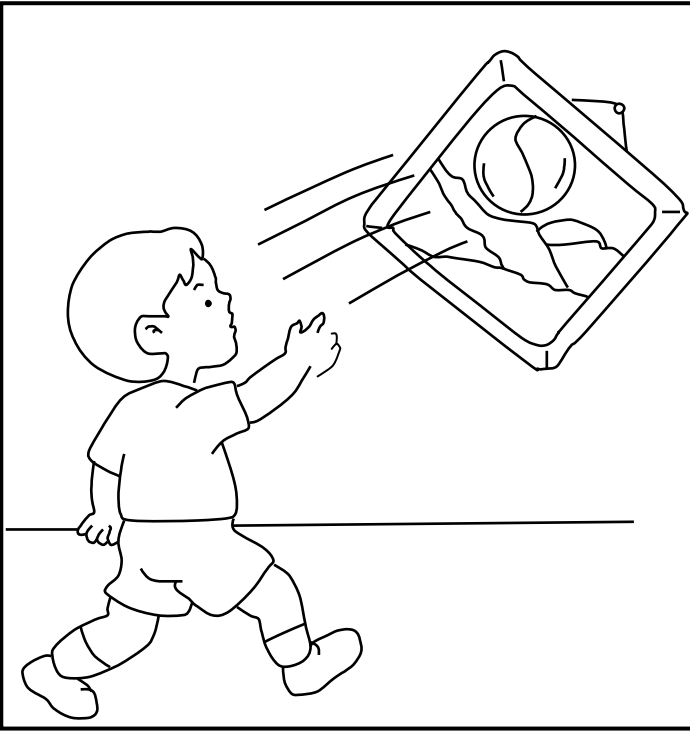
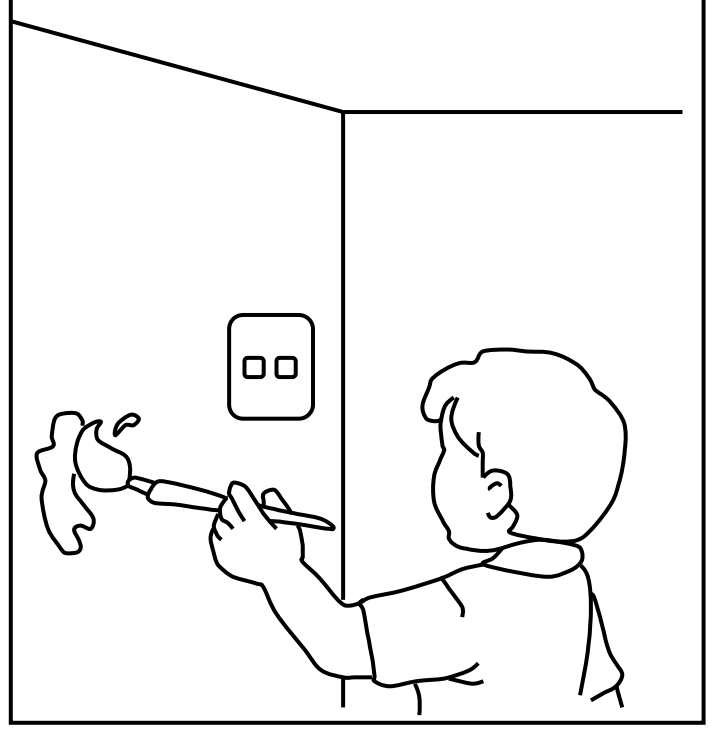

أرسم شكل المربع.

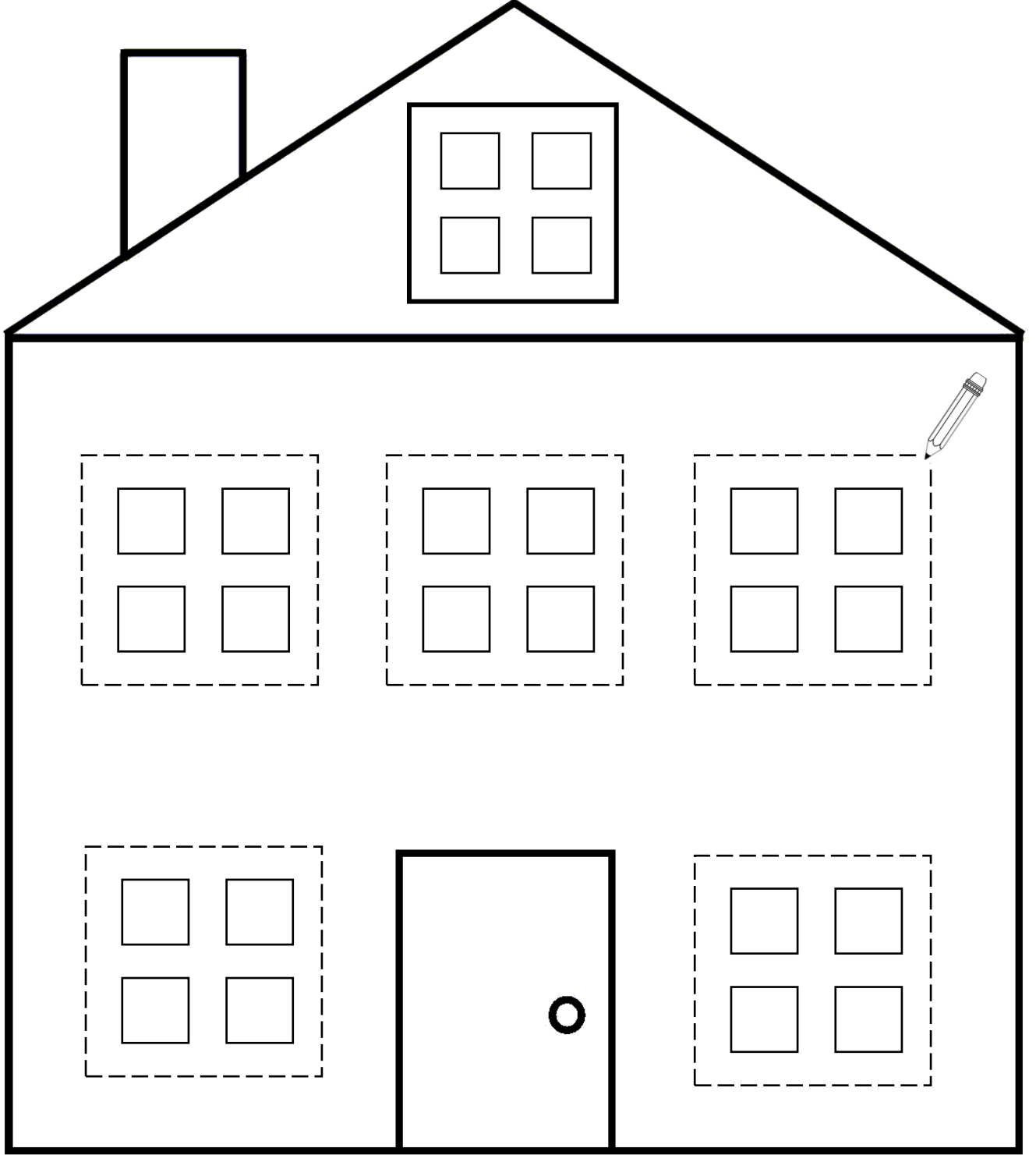



وحدة

رمضان



نكثر من العبادات في رمضان.

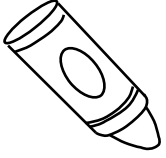

أقرأ القرآن الكريم



أدعوا ربي



أصلي



أتعرف على بعض من أكالات رمضان ، أطابق وأصل.

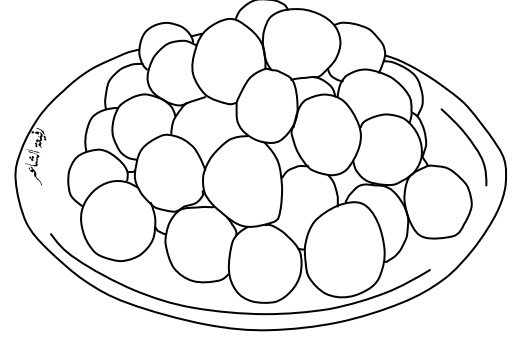
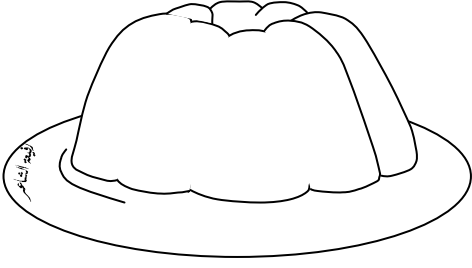

لقيمات

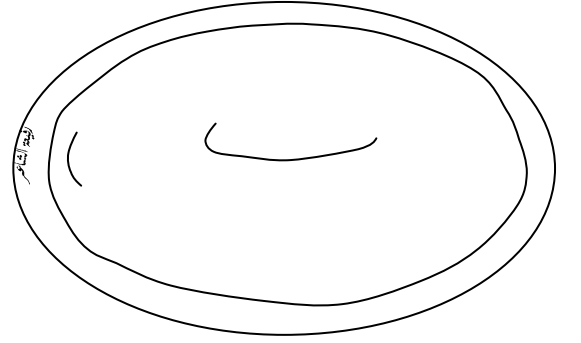
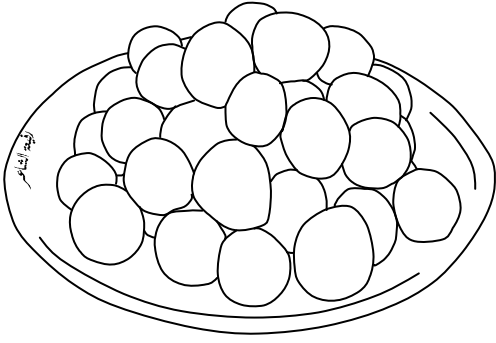

هريس

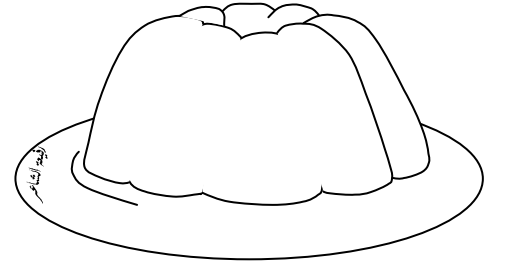
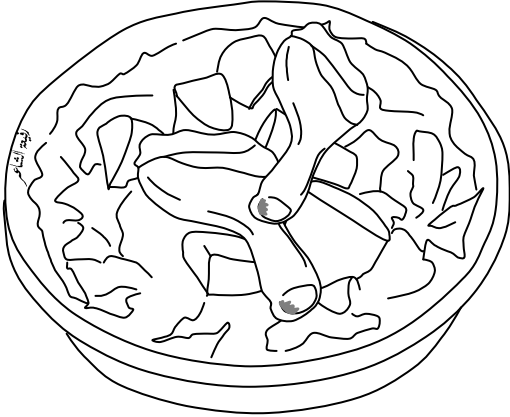

جيلي

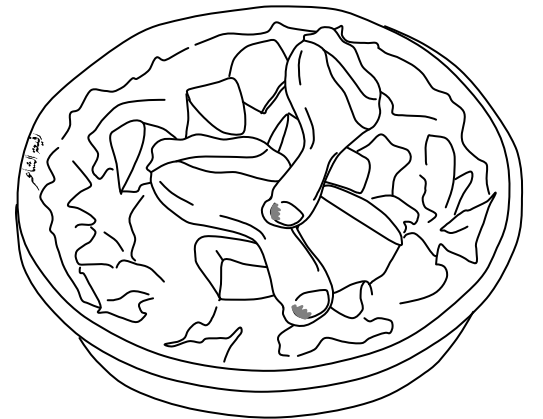
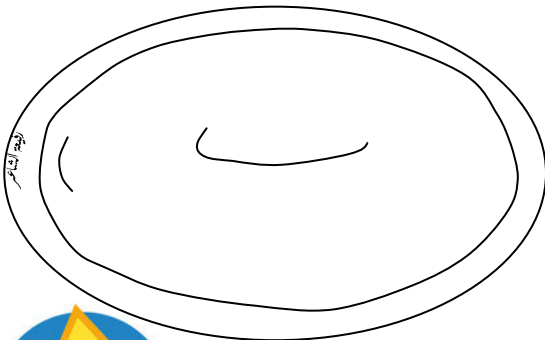

ثريد



أصل الرجل وابنه إلى المسجد.

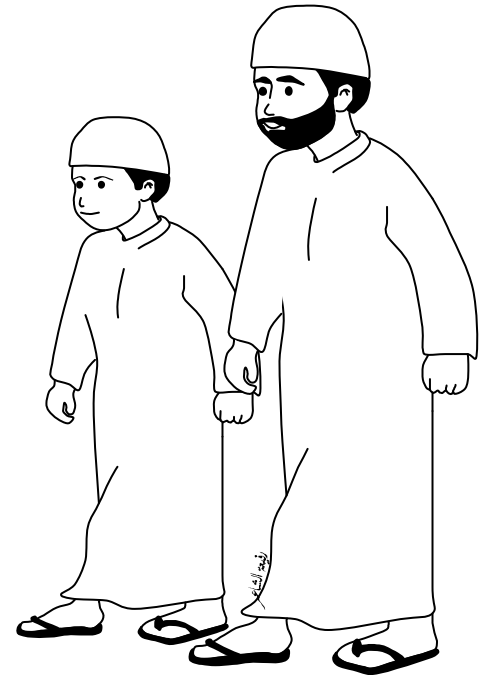
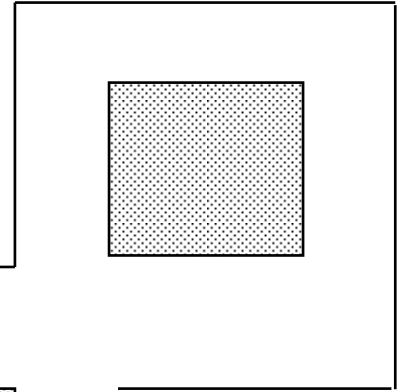
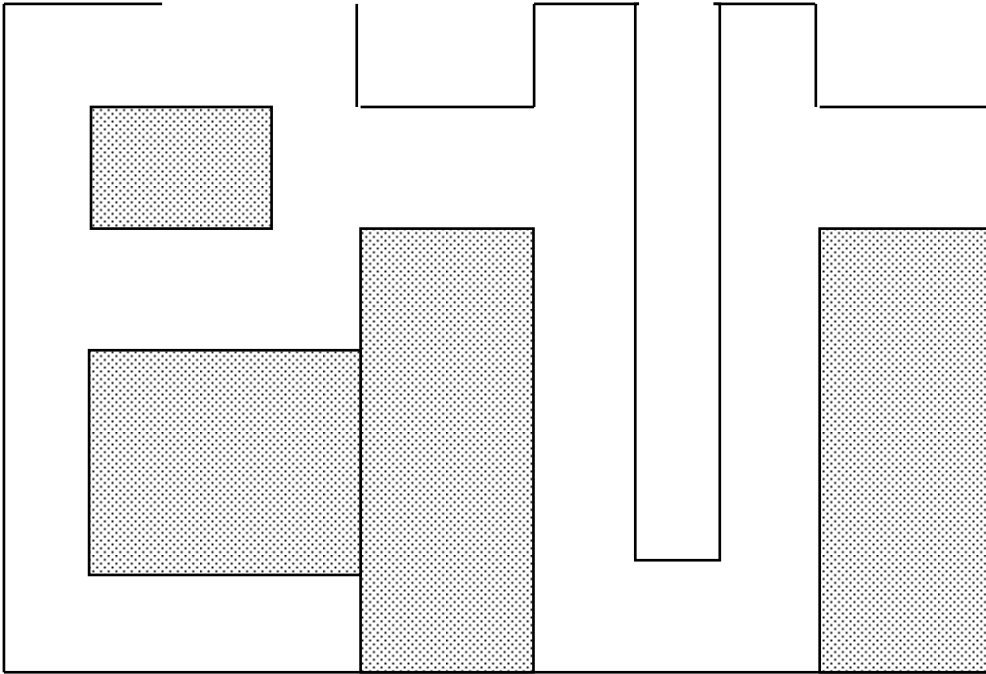
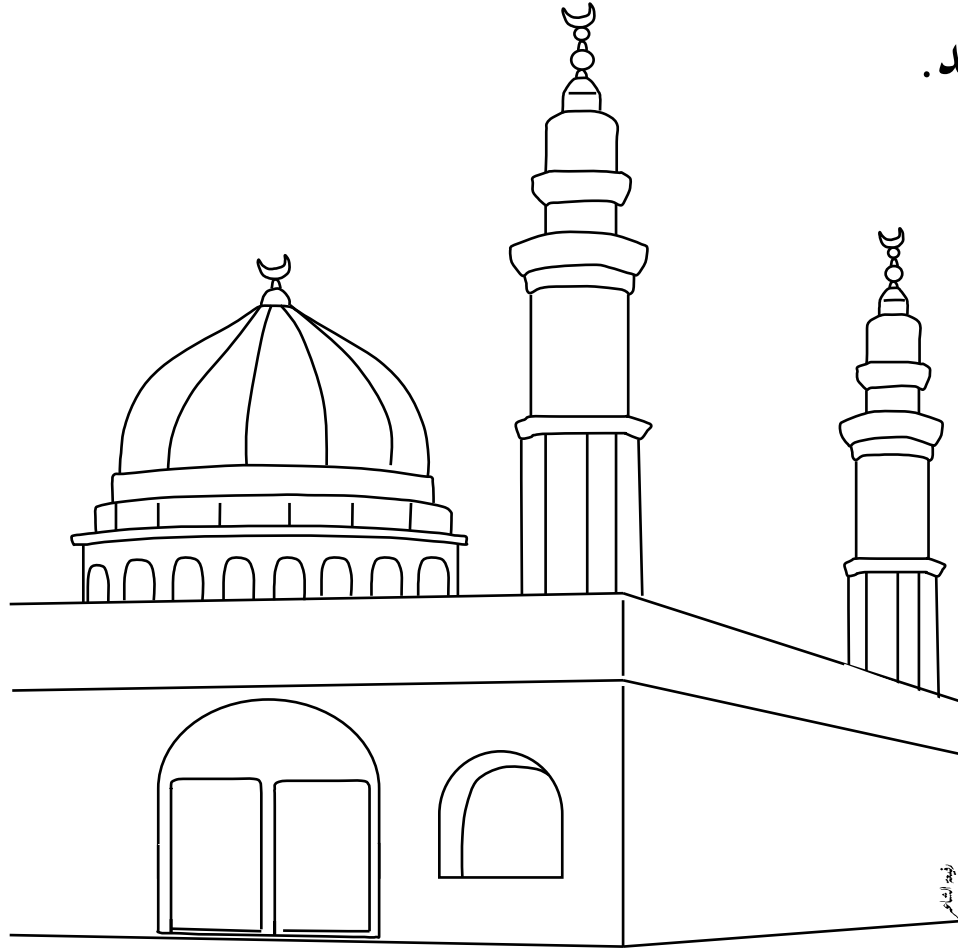

أخطط و ألون.

الله أكبر.. الله أكبر

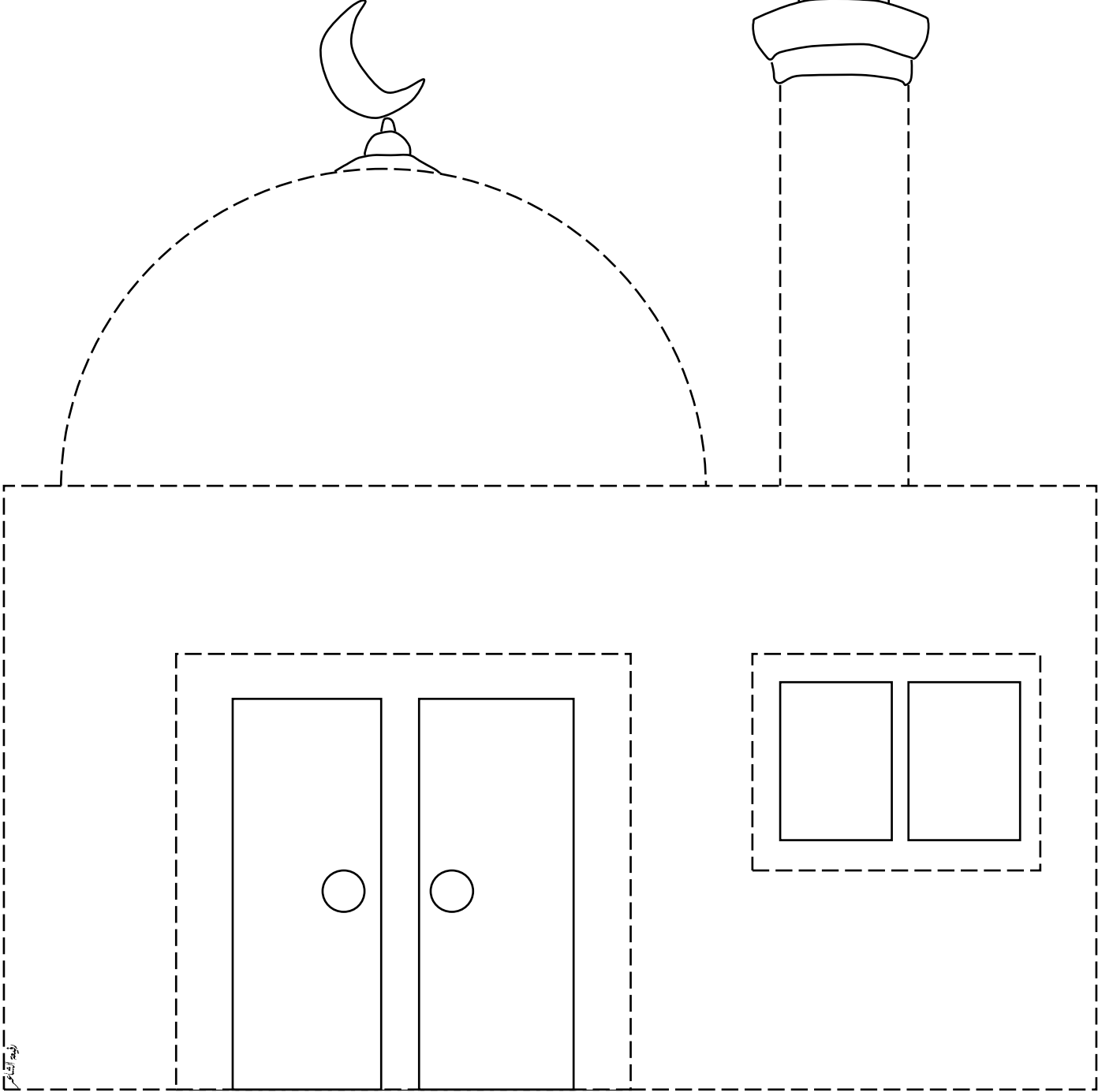
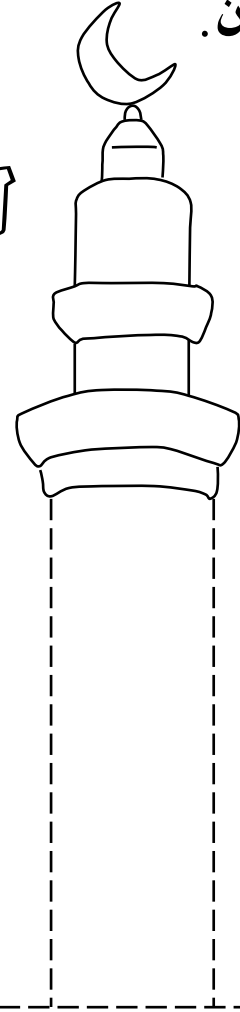

وحدة

الملبس



تختلف الملابس من حيث الاستعمال . أصل .

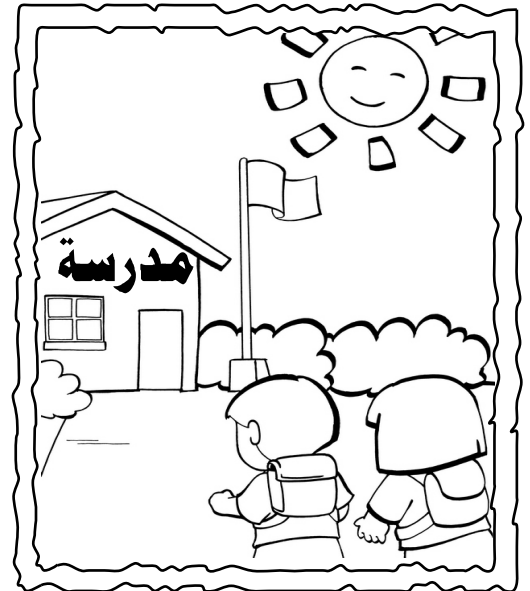

أحوط الملابس المناسب لكل جزء من جسمي.

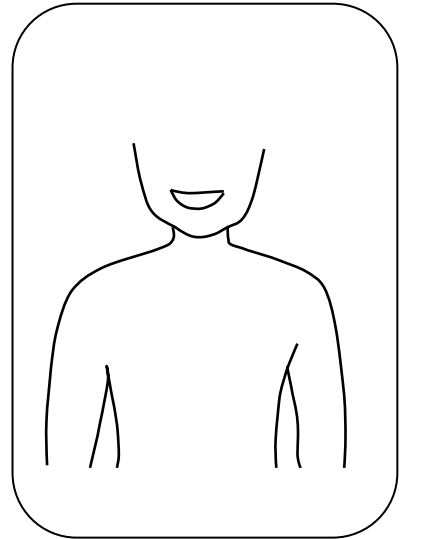
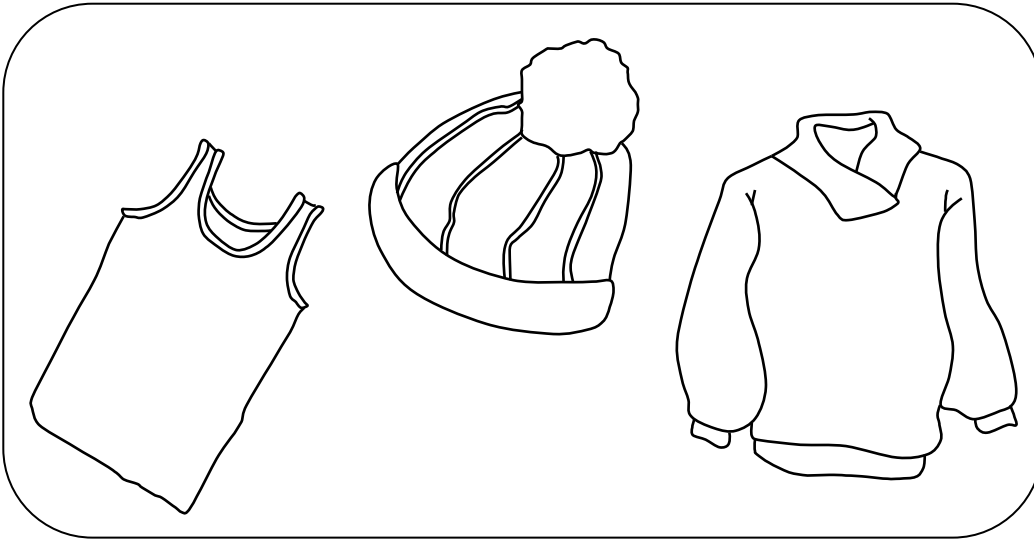
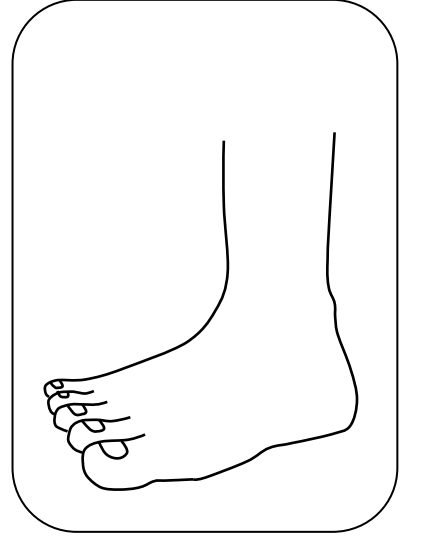
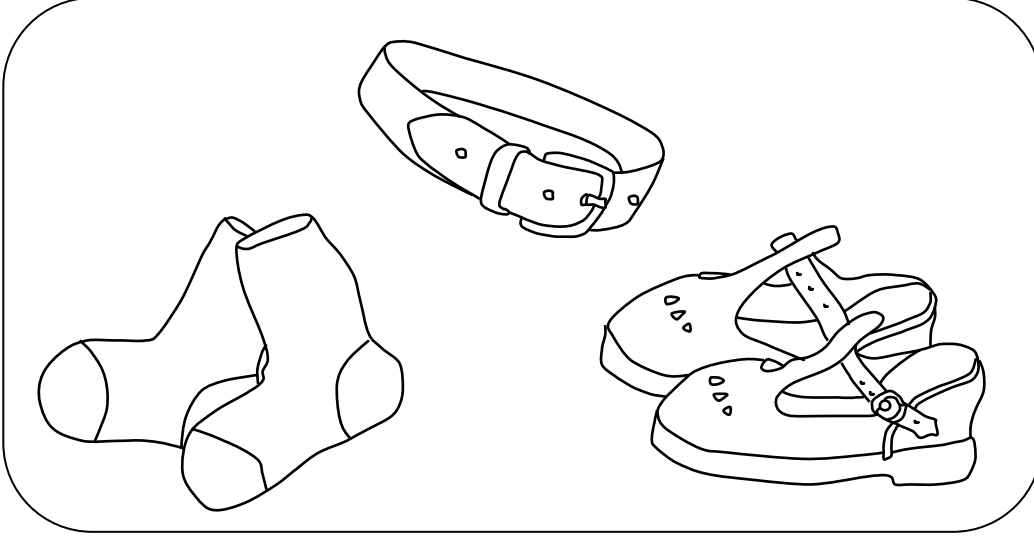
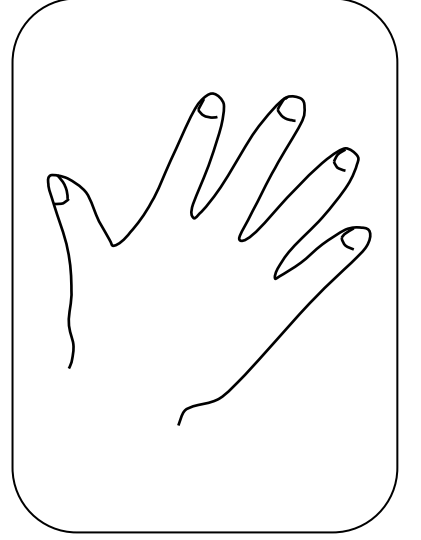
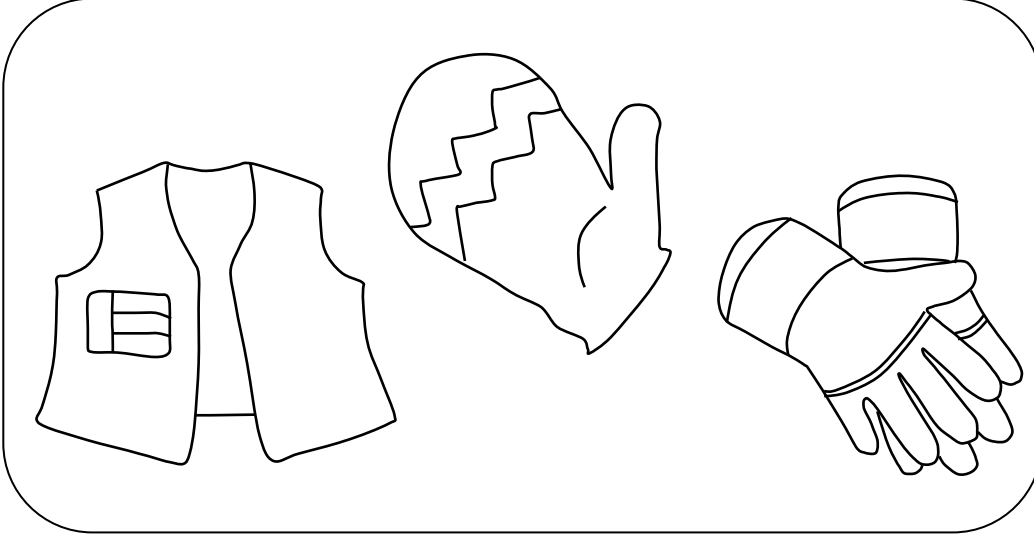

أصل البنت بملابسها والولد بملابسه.

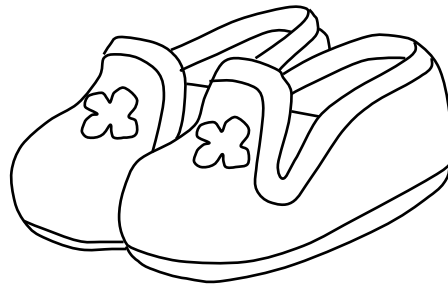
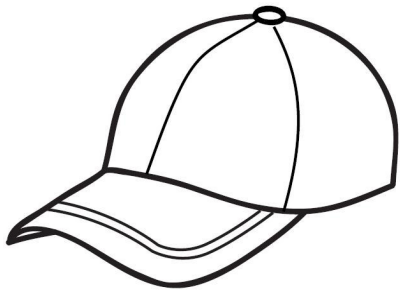
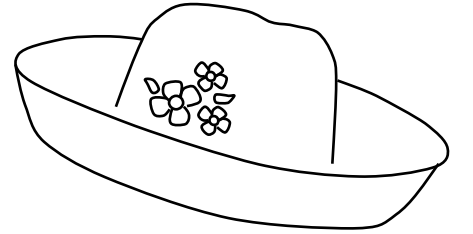
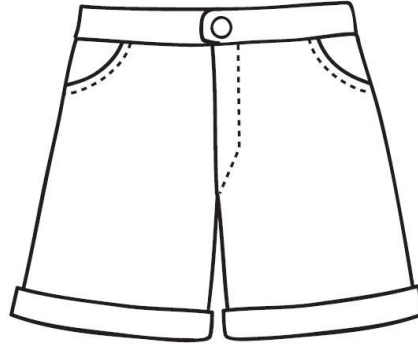
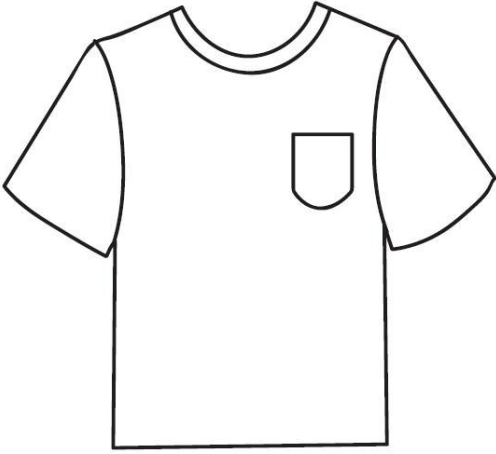
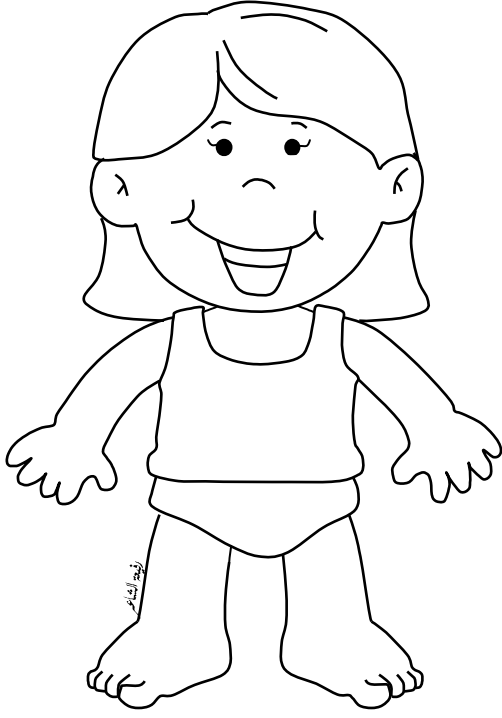

ألون ما ألبسه في يوم ممطر.

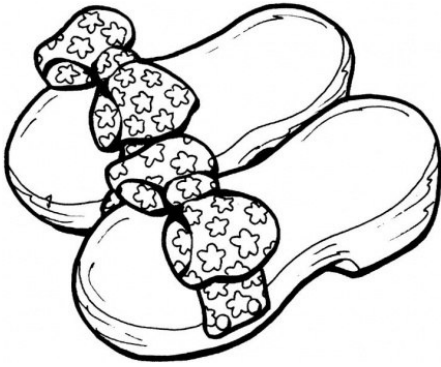
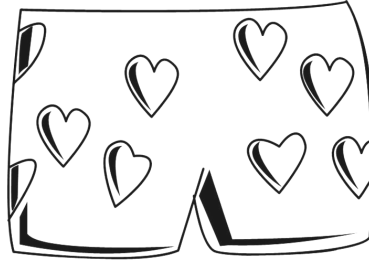
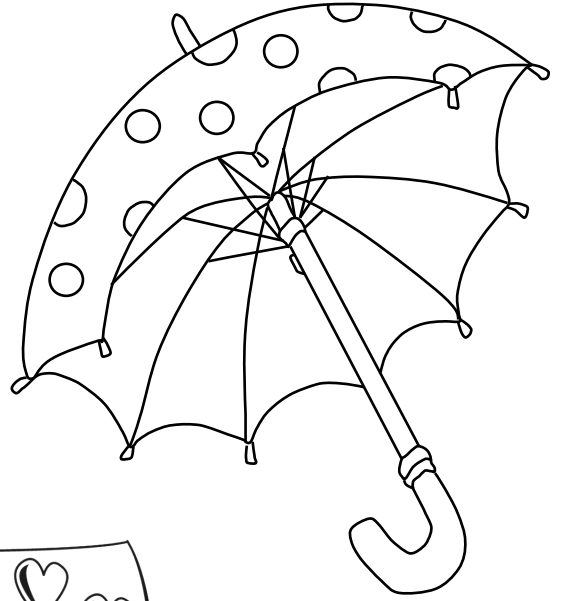
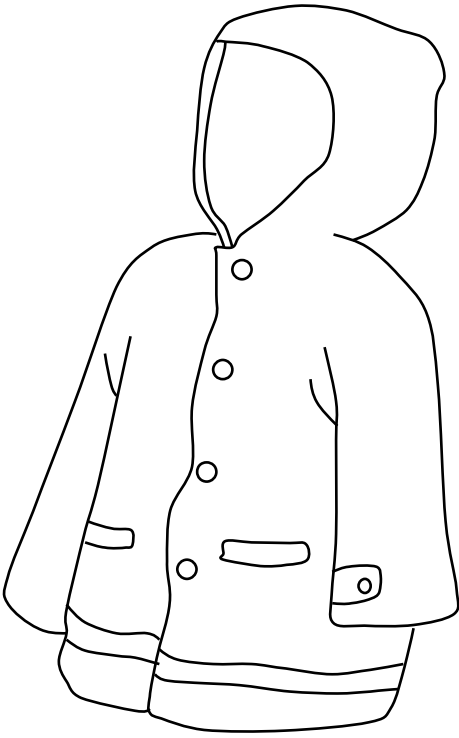
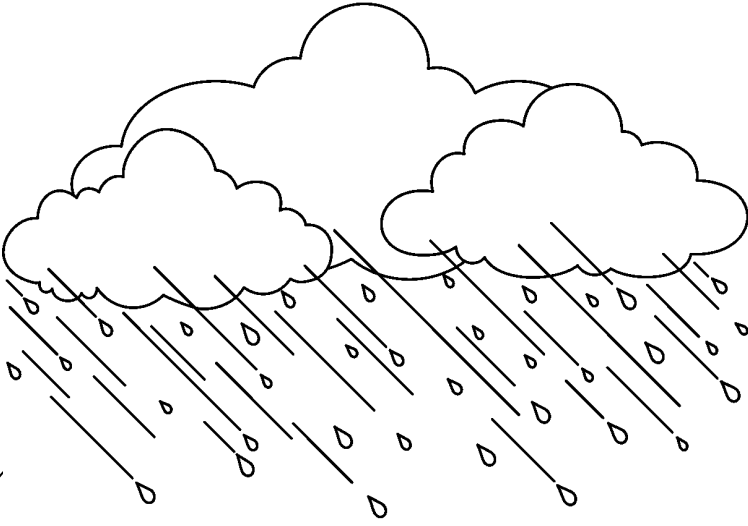

ألون ما ألبسه في يوم مشمس.

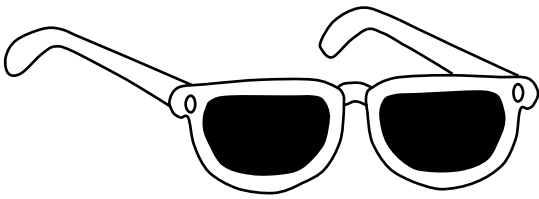
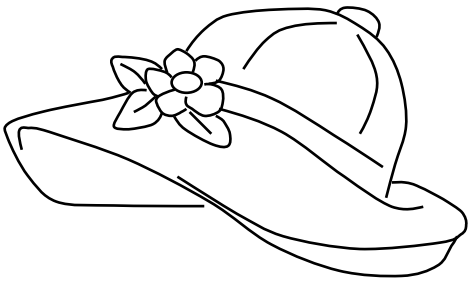
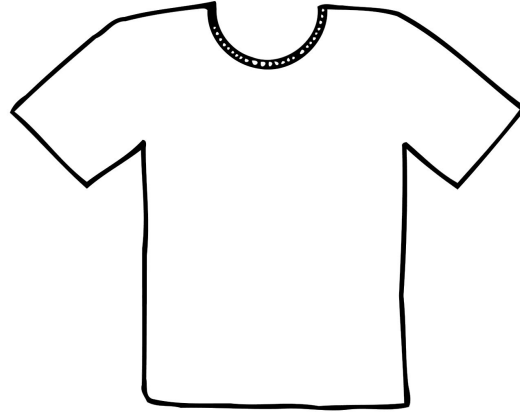
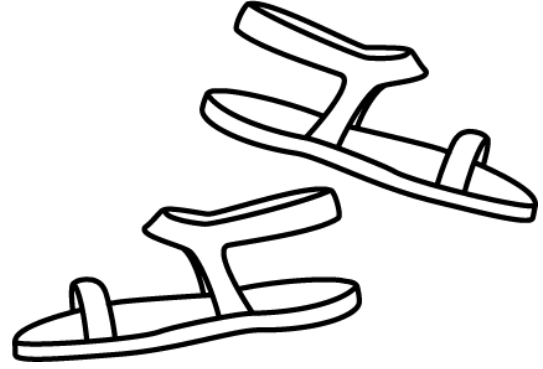
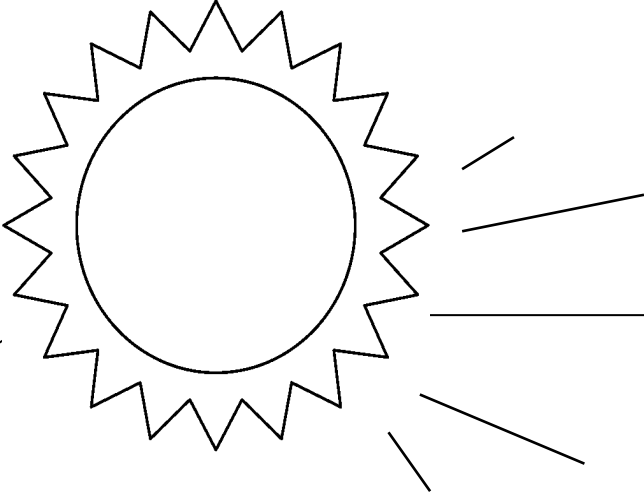

ألون ما ألبسه في يوم بارد.



ألون أحذيتي.

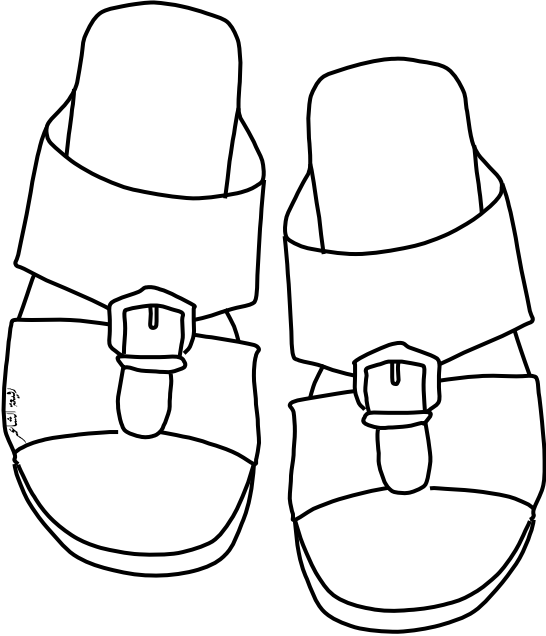
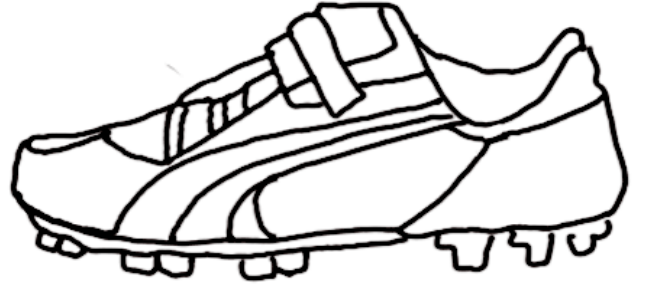
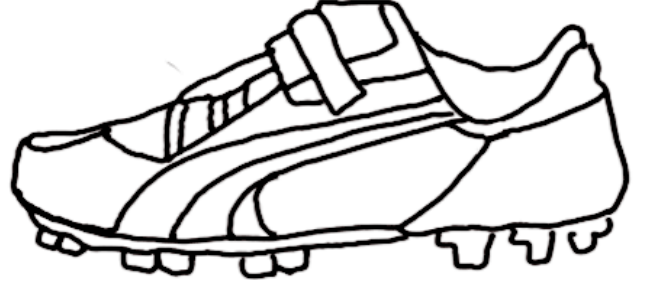
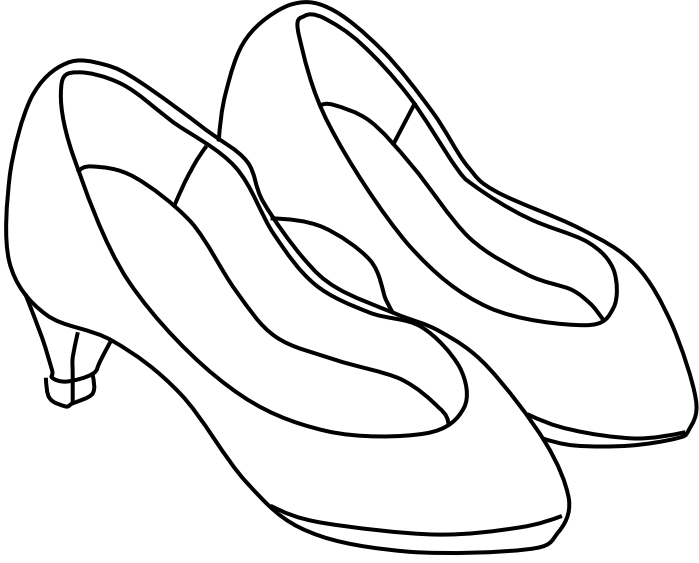

يلون الطالب أحذيته، وتلون الطالبة أحذيتها.



وحدة

اليوم الوطني



ألون اسم بلادي الإمارات.

الإمارات

الإمارات

عمان

العراق

الإمارات

الكويت



الإمارات

قطر



أتعرف على حكام الإمارات . أطابق وأصل .



خليفة بن زايد آل نهيان



سلطان بن محمد القاسمي



محمد بن راشد آل مكتوم



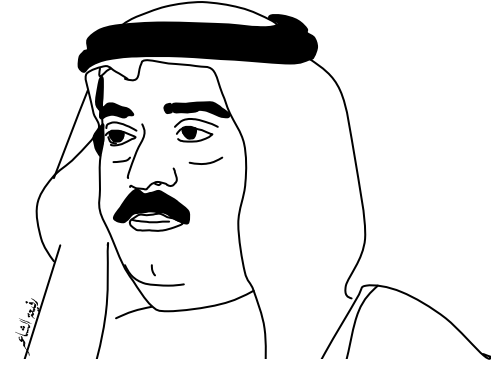
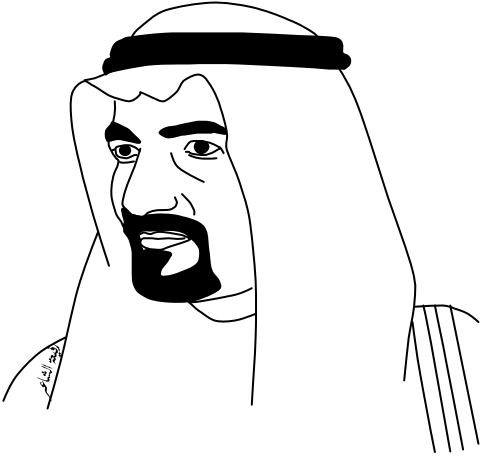

سعود بن راشد المعلا

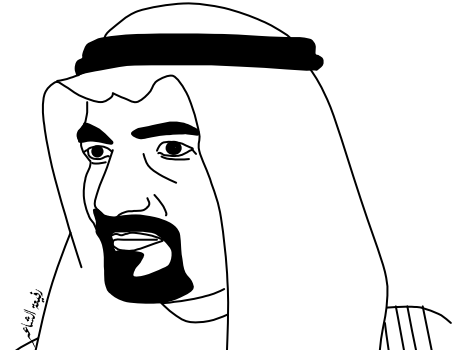

حمد بن محمد الشرقي

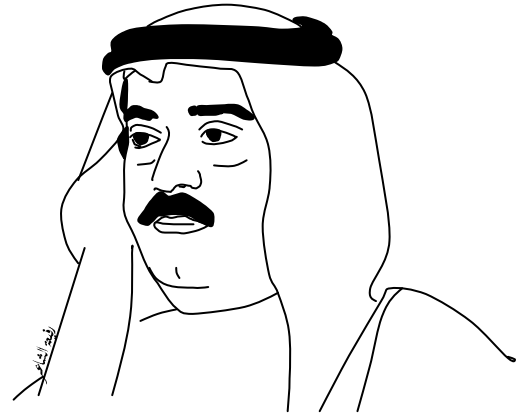

حميد بن راشد النعيمي



سعود بن صقر القاسمي



ألون علم بلادي.

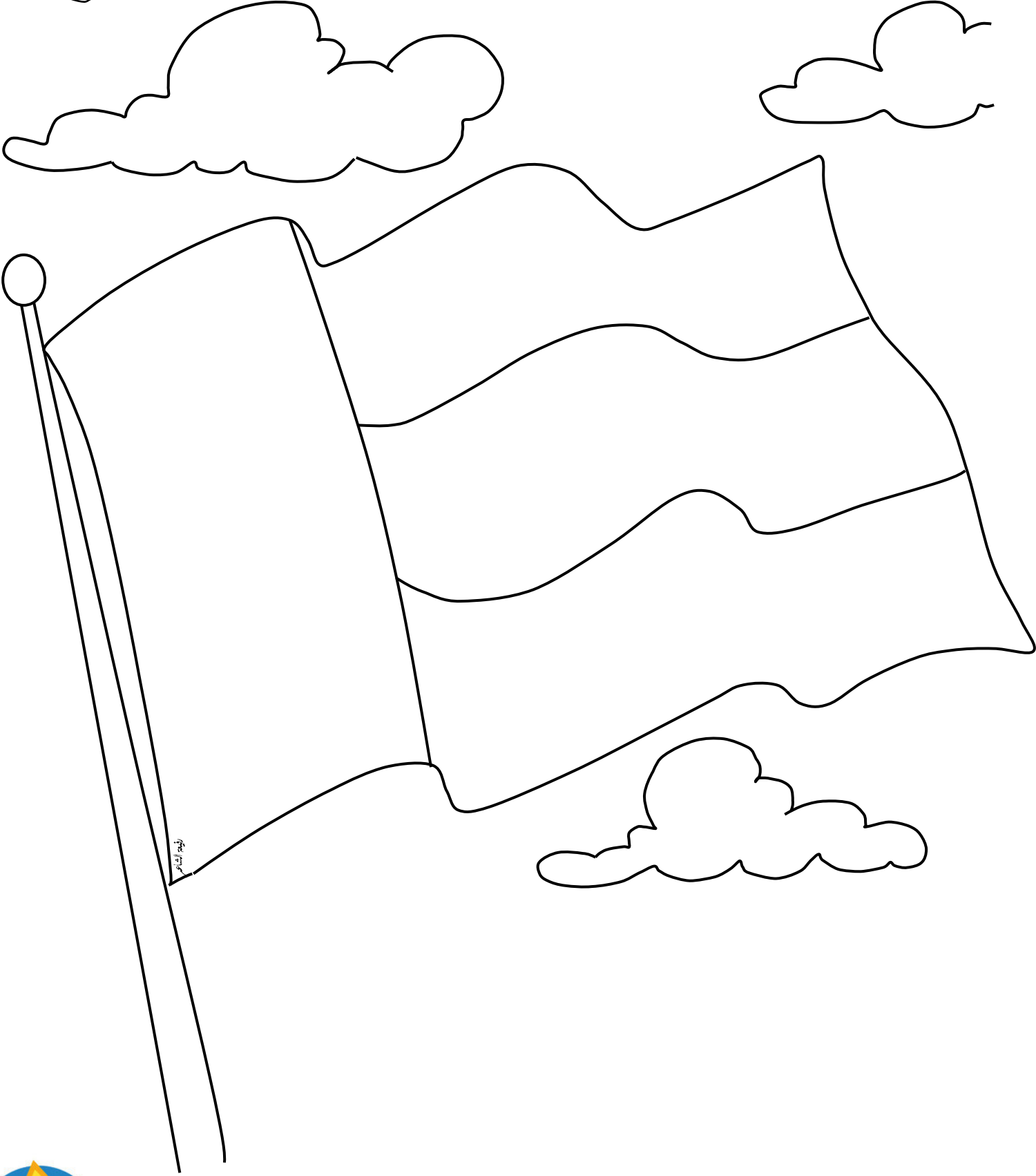
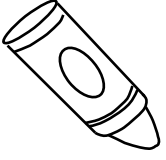

أطابق أسماء الإمارات السبع، أصل.

أم القيوين

رأس الخيمة

دبي

دبي

رأس الخيمة

أبوظبي

الشارقة

أم القيوين

أبوظبي

الفجيرة

عجمان

عجمان

الفجيرة

الشارقة



أحوط مظاهر الاحتفال باليوم الوطني.

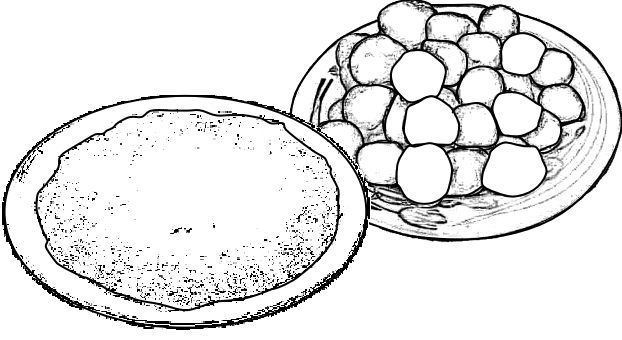

إعداد الأكلات الشعبية



الرقصات التراثية



الغوص

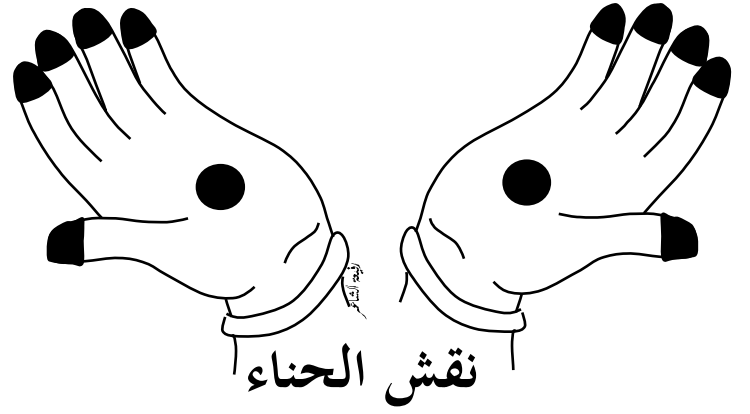

نقش الحناء



لبس الملابس التقليدية



لعب كرة القدم



وحدة

الطعام والشراب



أحوِّط مجموعة الطعام بدائرة ومجموعة الشراب بدائرة أخرى.

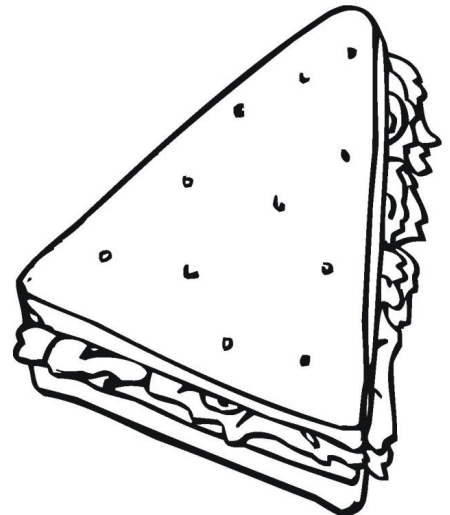
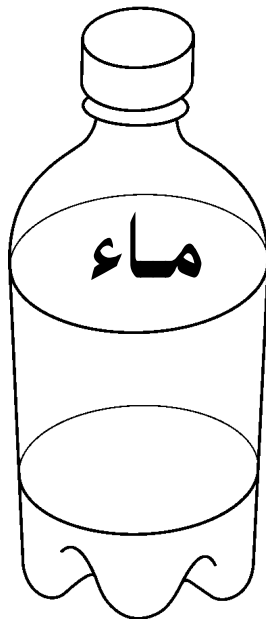
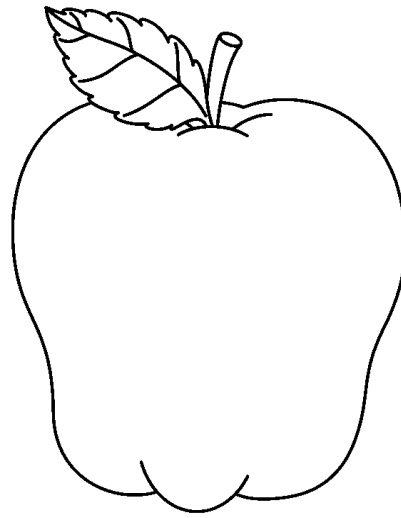
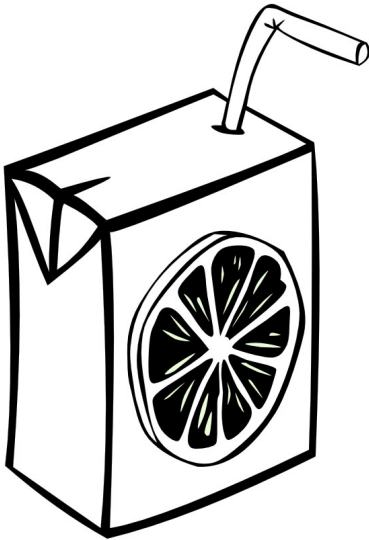
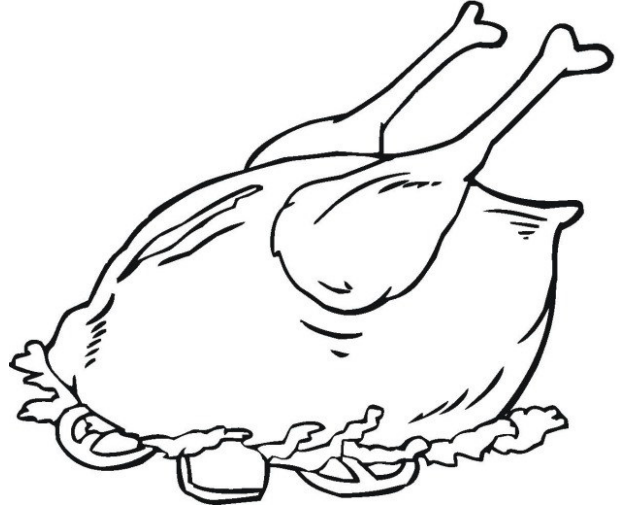
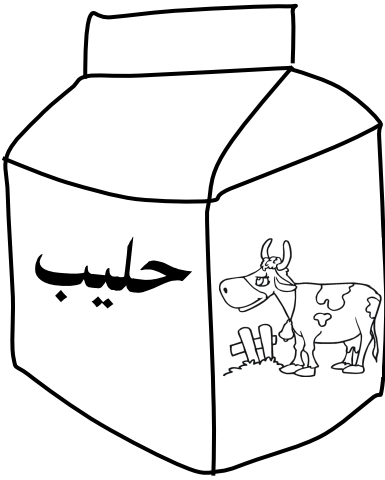

أصل الطعام بمكان شراءه.

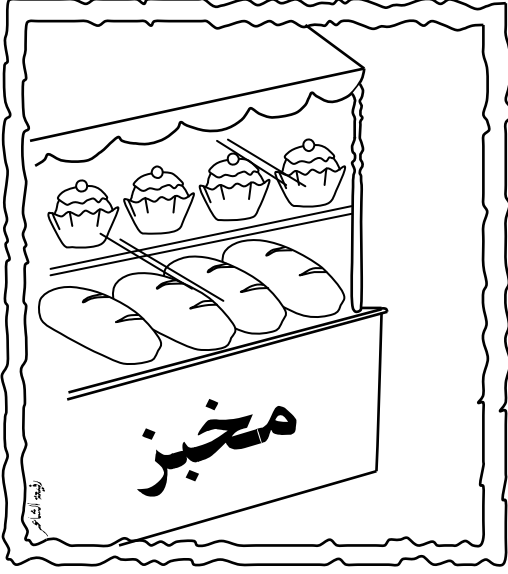

خضروات

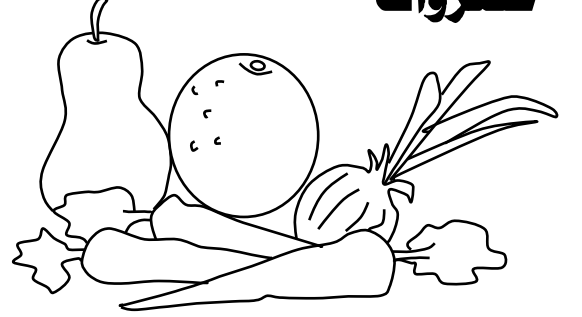

سمك

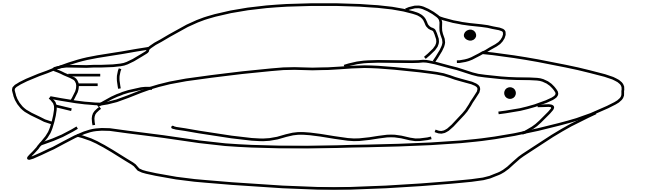

معجنات



ألون الخضروات.

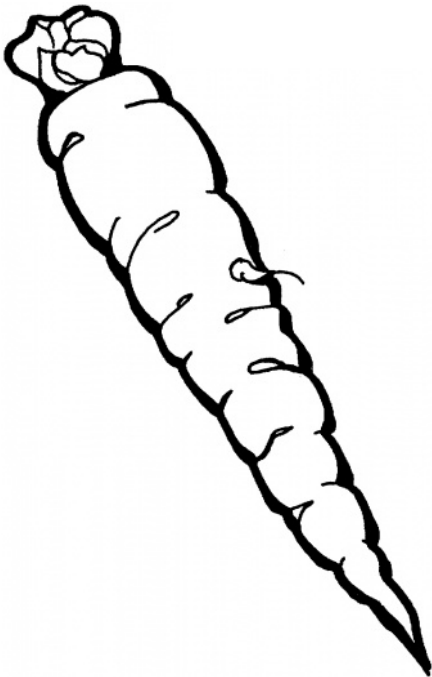
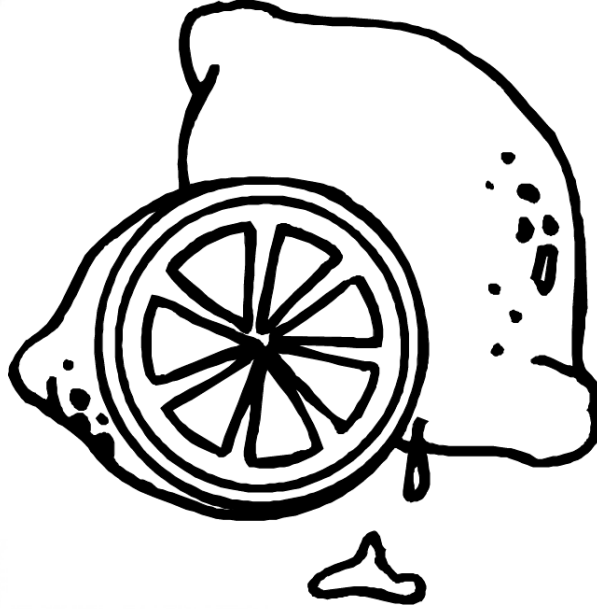
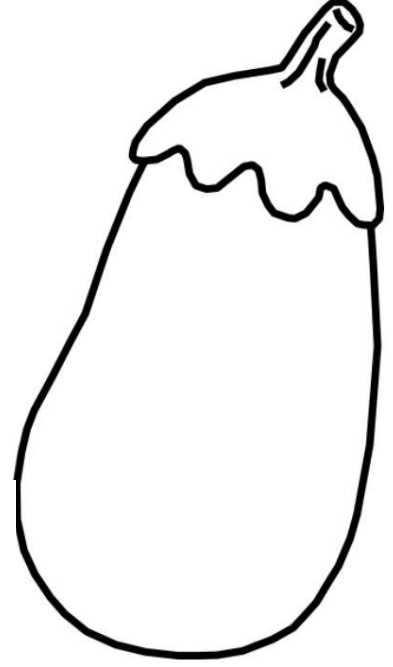
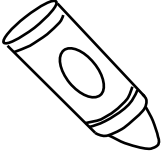

بعض طعامنا من منتجات الحيوان ، أصل.

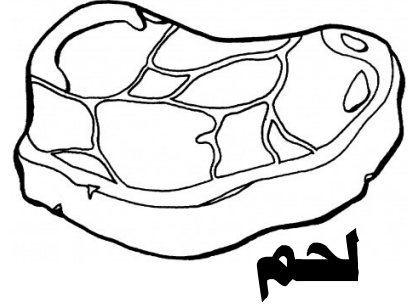
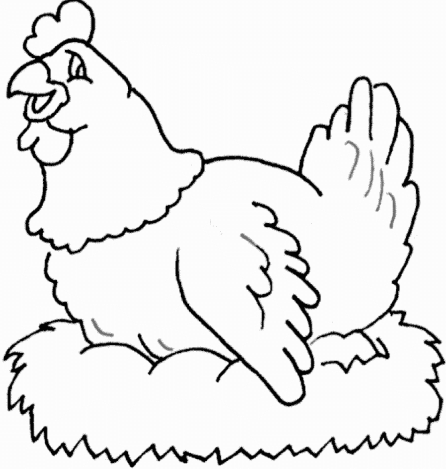

لحم

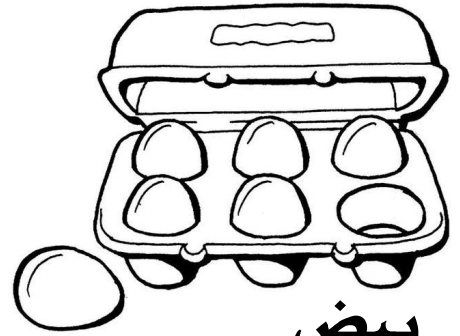

بيض

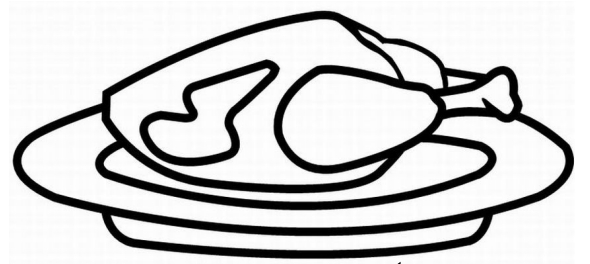
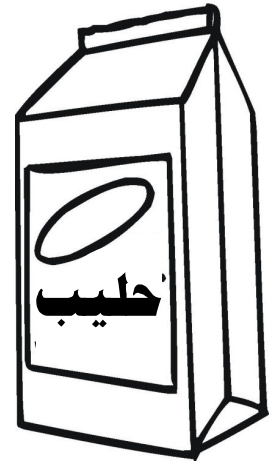
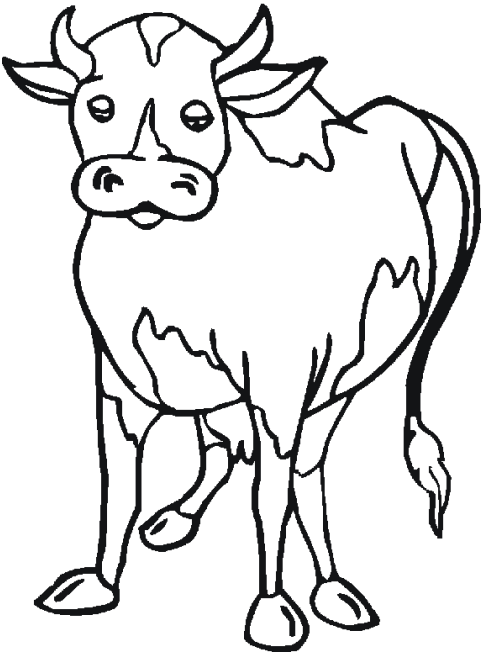

دجاج



" أكثر ، أقل " أحوٲ الأكثر.

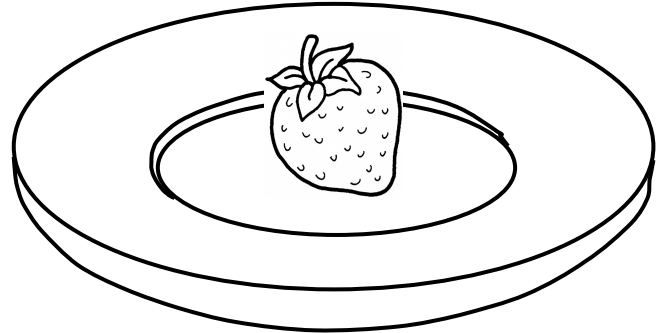
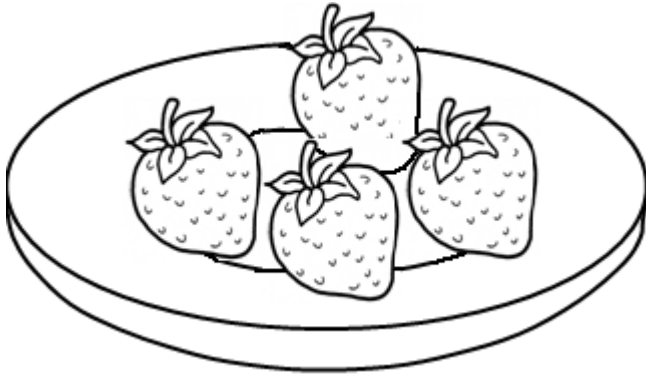
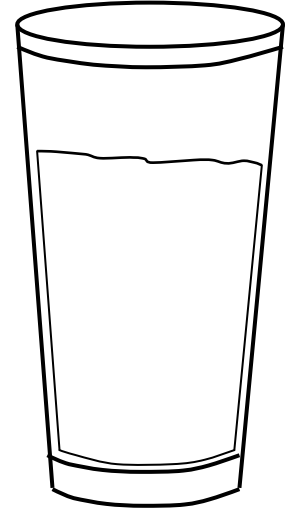
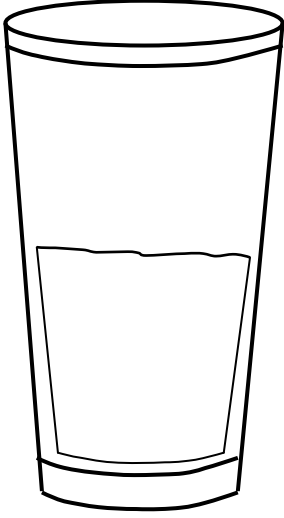



وحدة

الحيوانات



مساكن الحيوانات، أصل الحيوان بمسكنه.

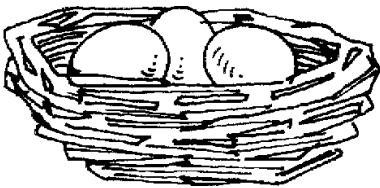
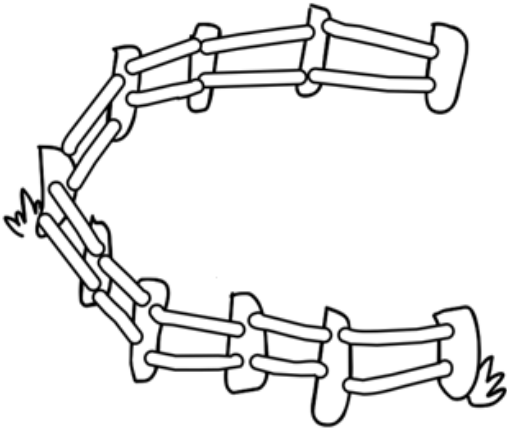
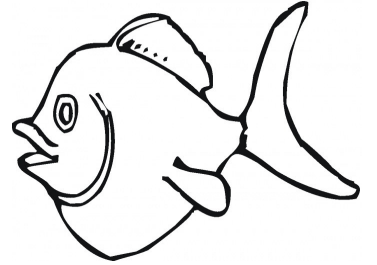
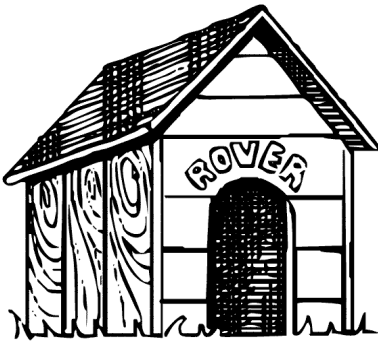
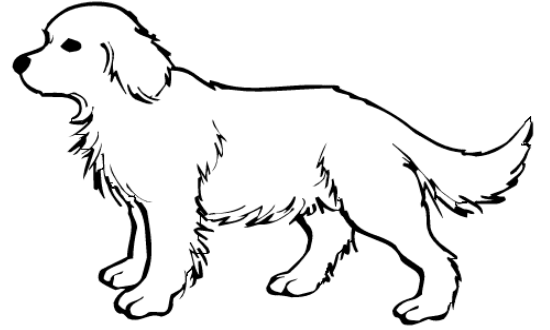

أصل الحيوان بنصفه الآخر.

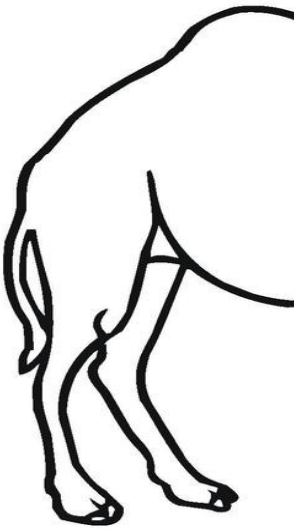
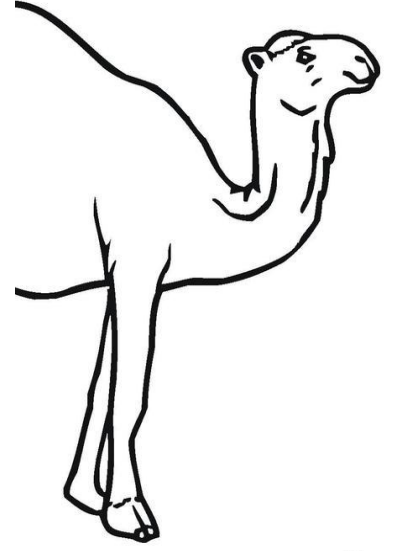
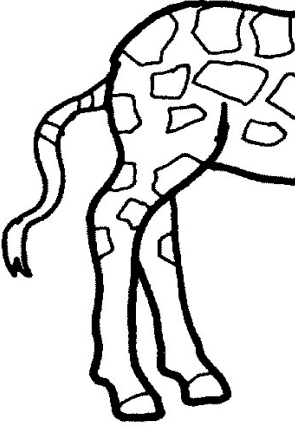

ألون حيواني المفضل.

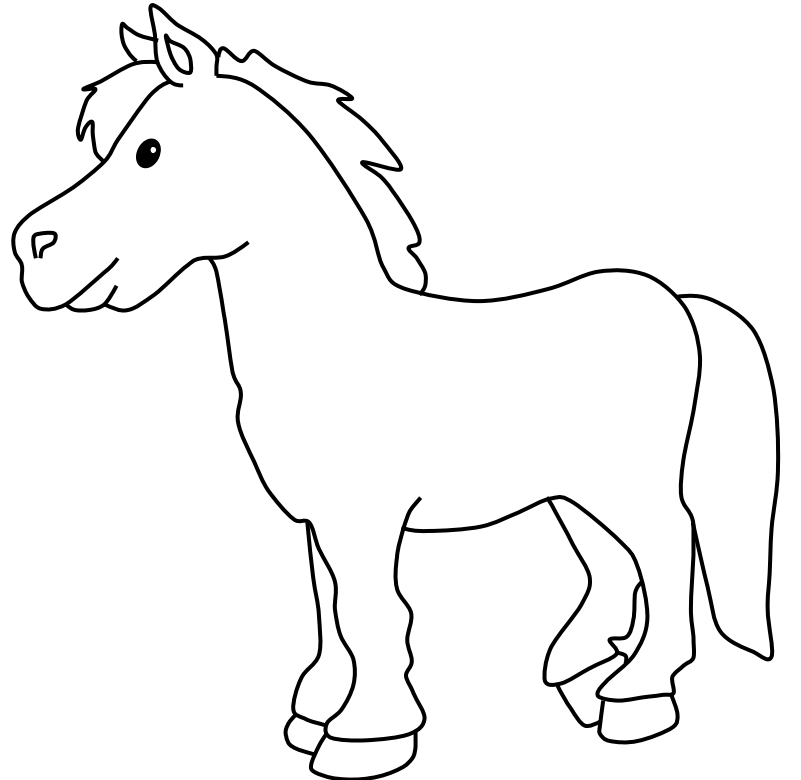
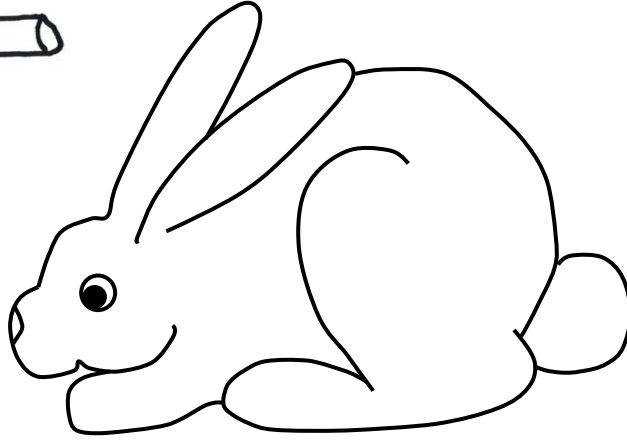
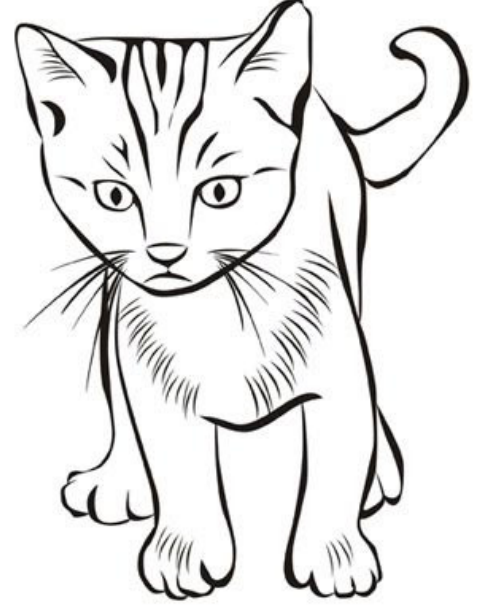
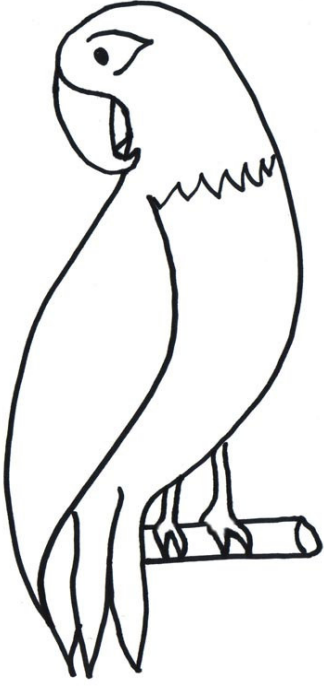

طعام الحيوانات، أصل الحيوان إلى طعامه.



خضار

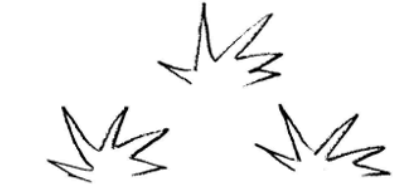
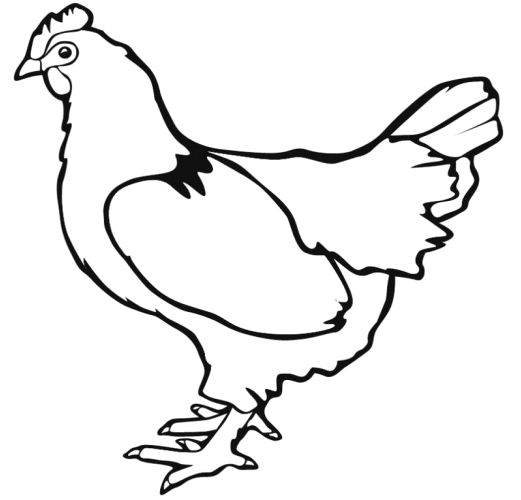

عشب

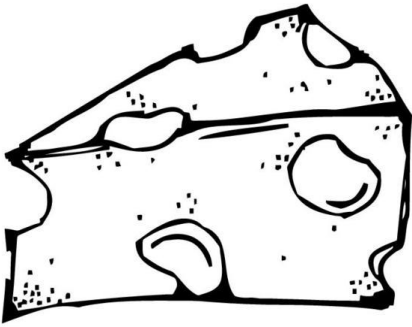

جبين

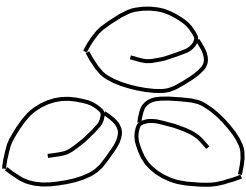
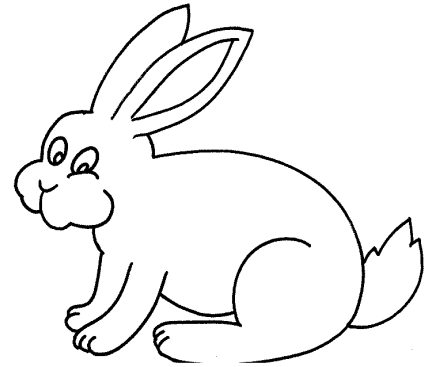

شعير

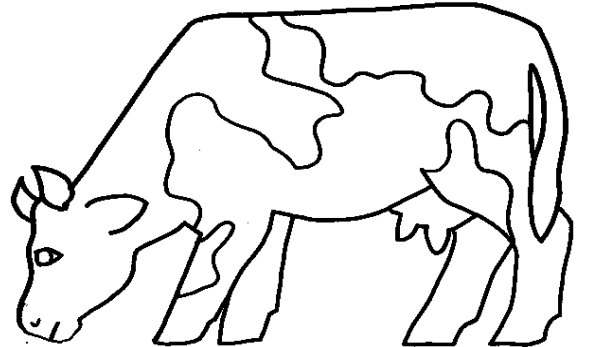

أرسم علامة **X** على السلوك الخاطئ في التعامل مع الحيوانات.

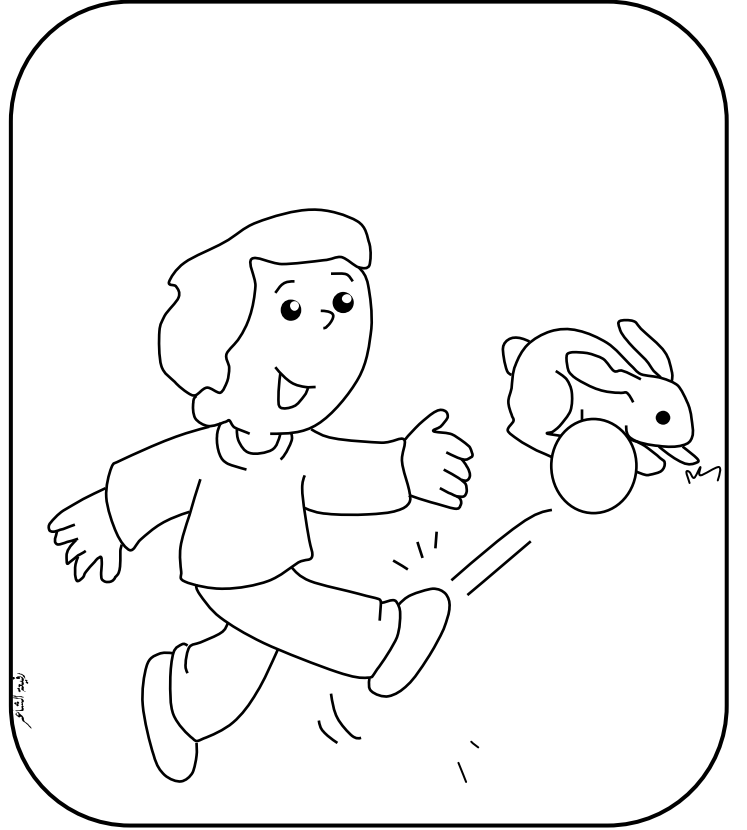
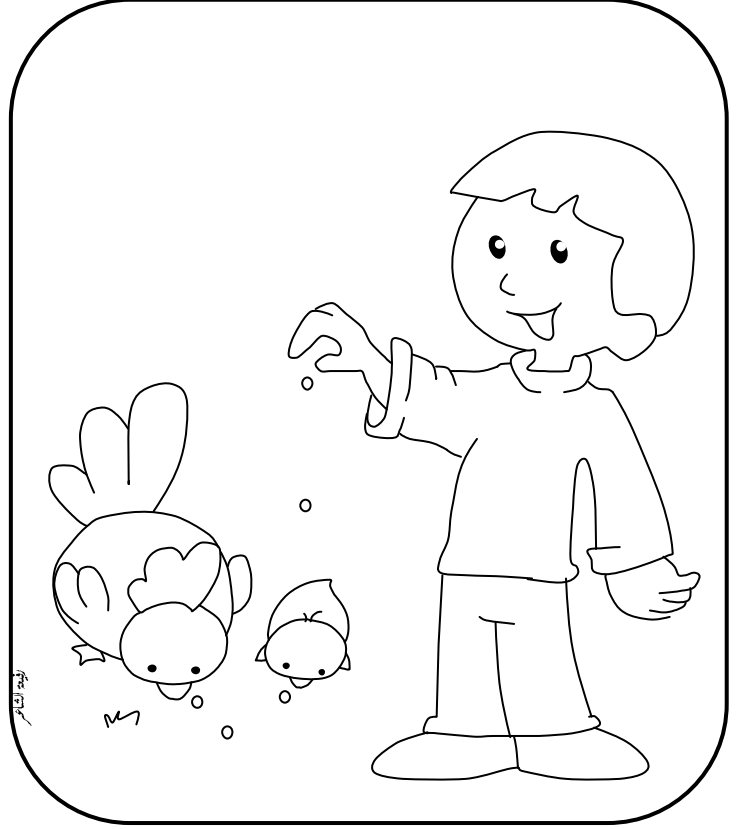

عائلة الحيوانات ، أصل الحيوان إلى صغيره.

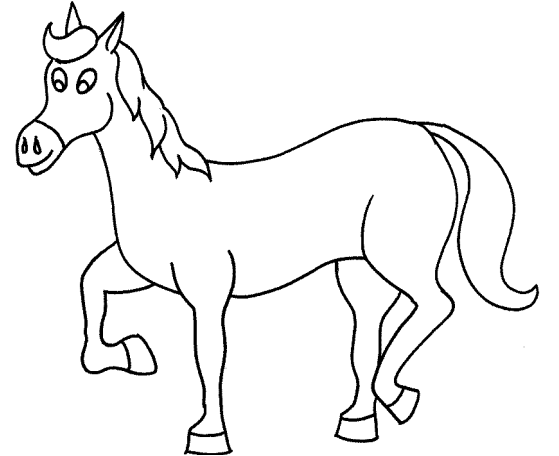
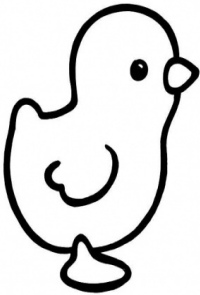
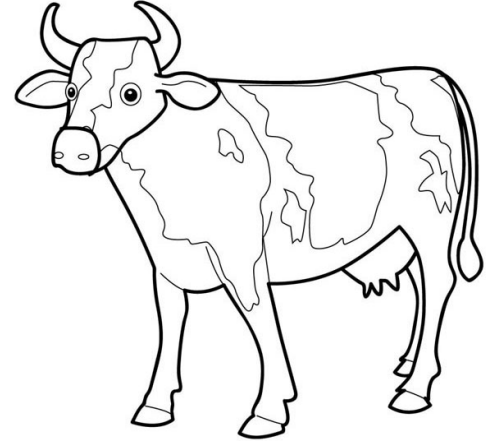
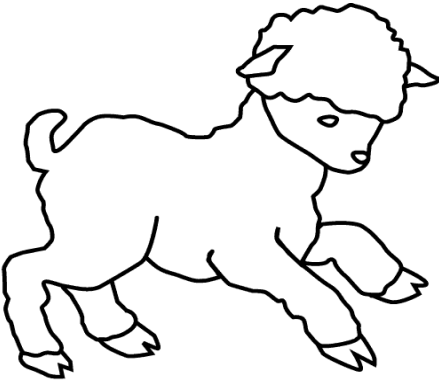
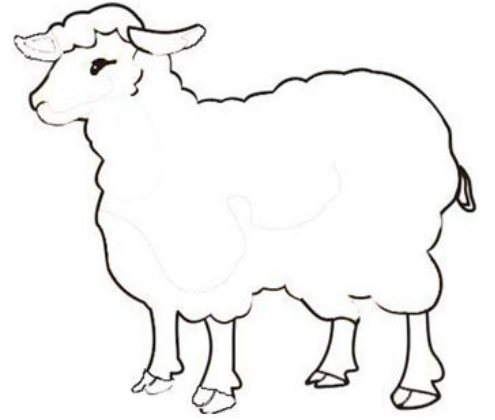
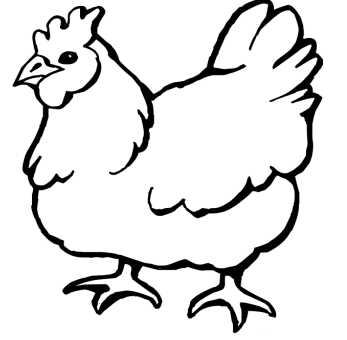
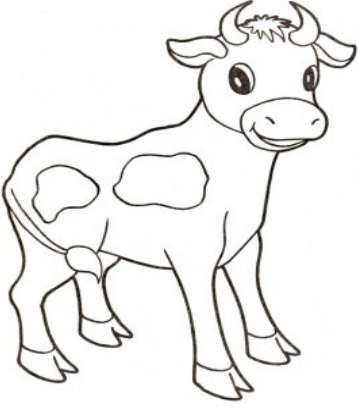

الحيوانات مختلفة، أصل الحيوانات بأجزائها.

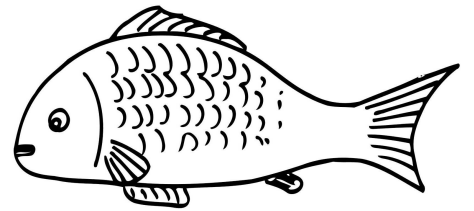
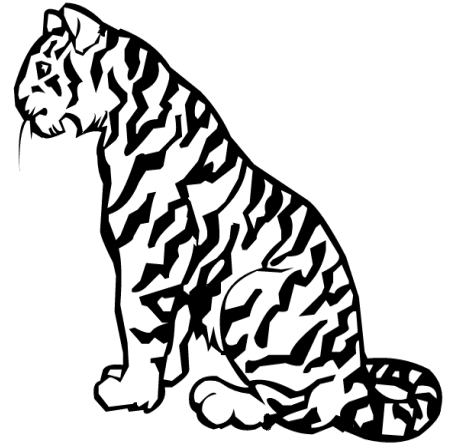
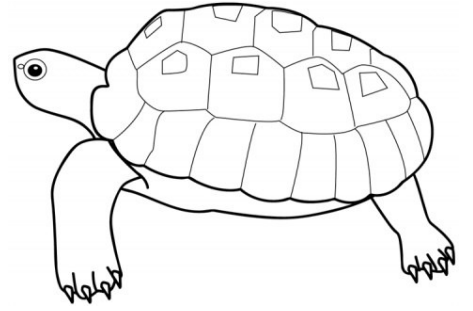
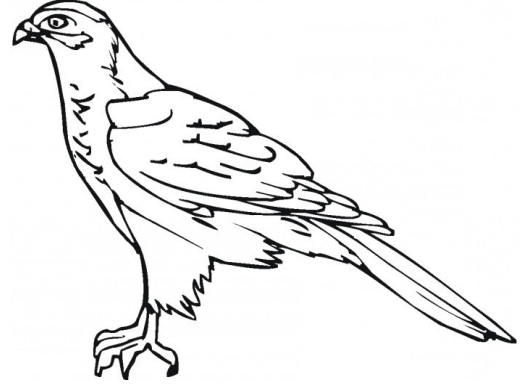
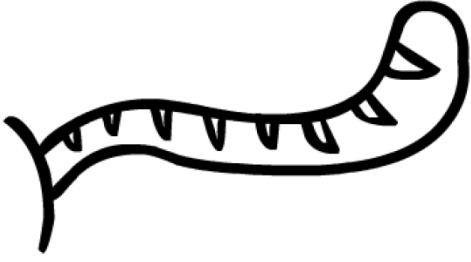



وحدة

الصحراء



أتعرف على حيوانات الصحراء ، أقرأ و ألون.



جربوع

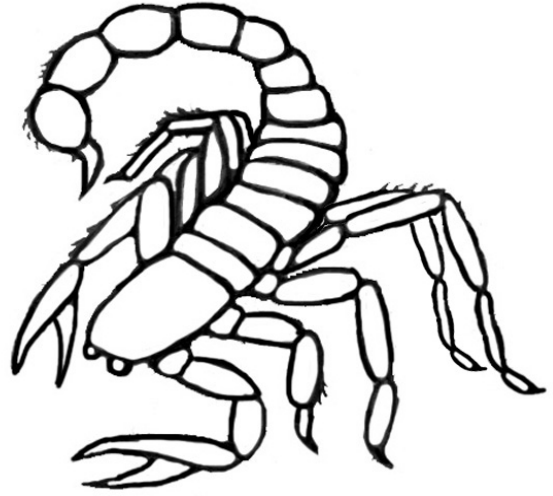

عقرب



سحلية

جمال

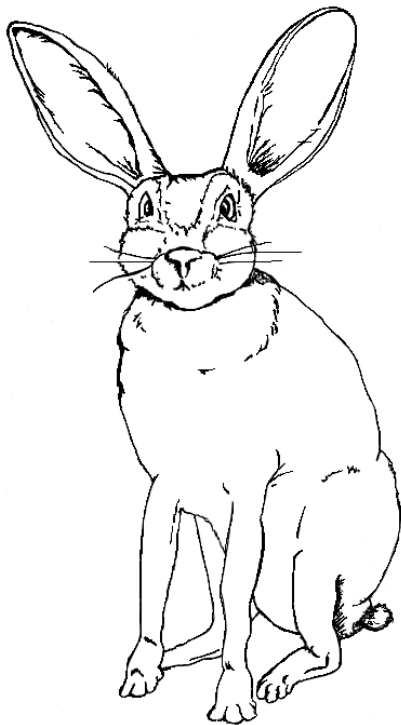

أرنب

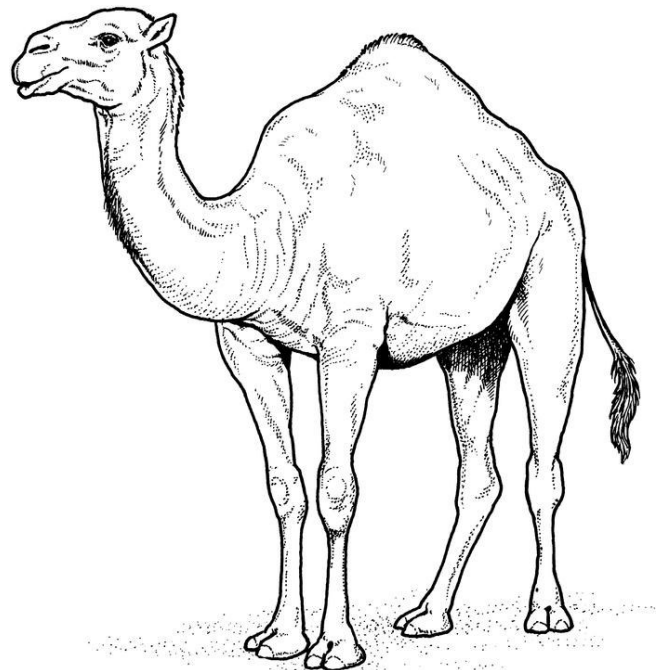

أحوط محتويات الصحراء.

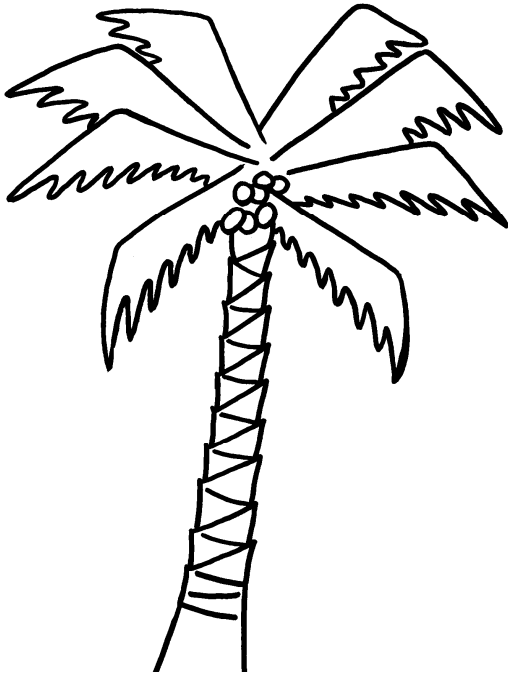
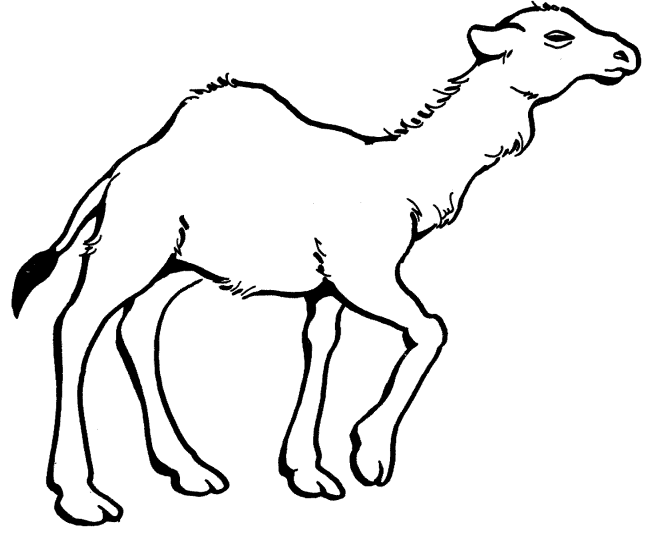
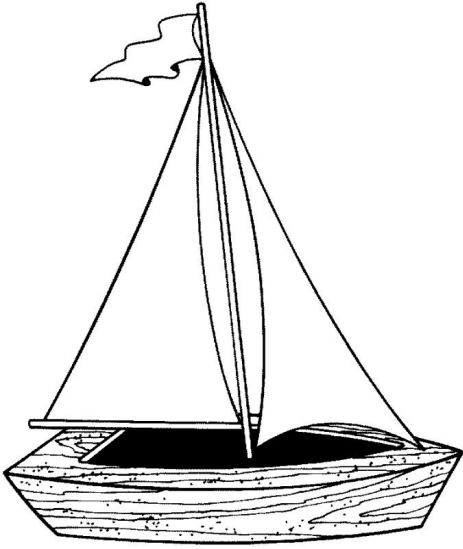
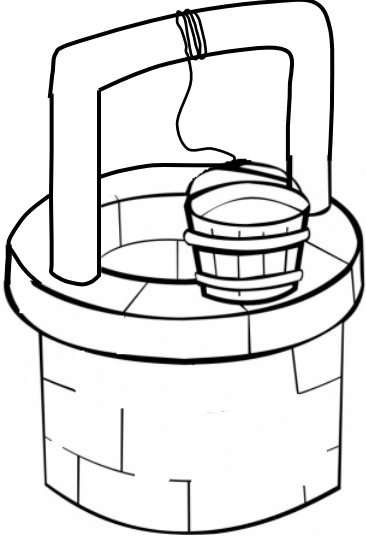

ألون رمل الشاطئ.

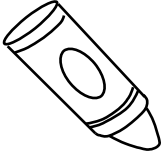

رمل الشاطئ

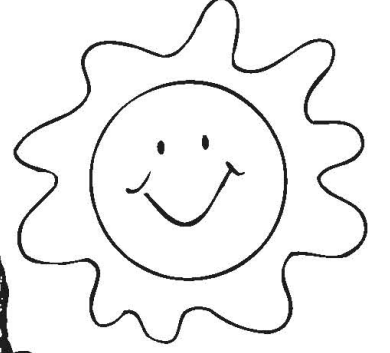

ألون رمل الصحراء.

رمل الصحراء

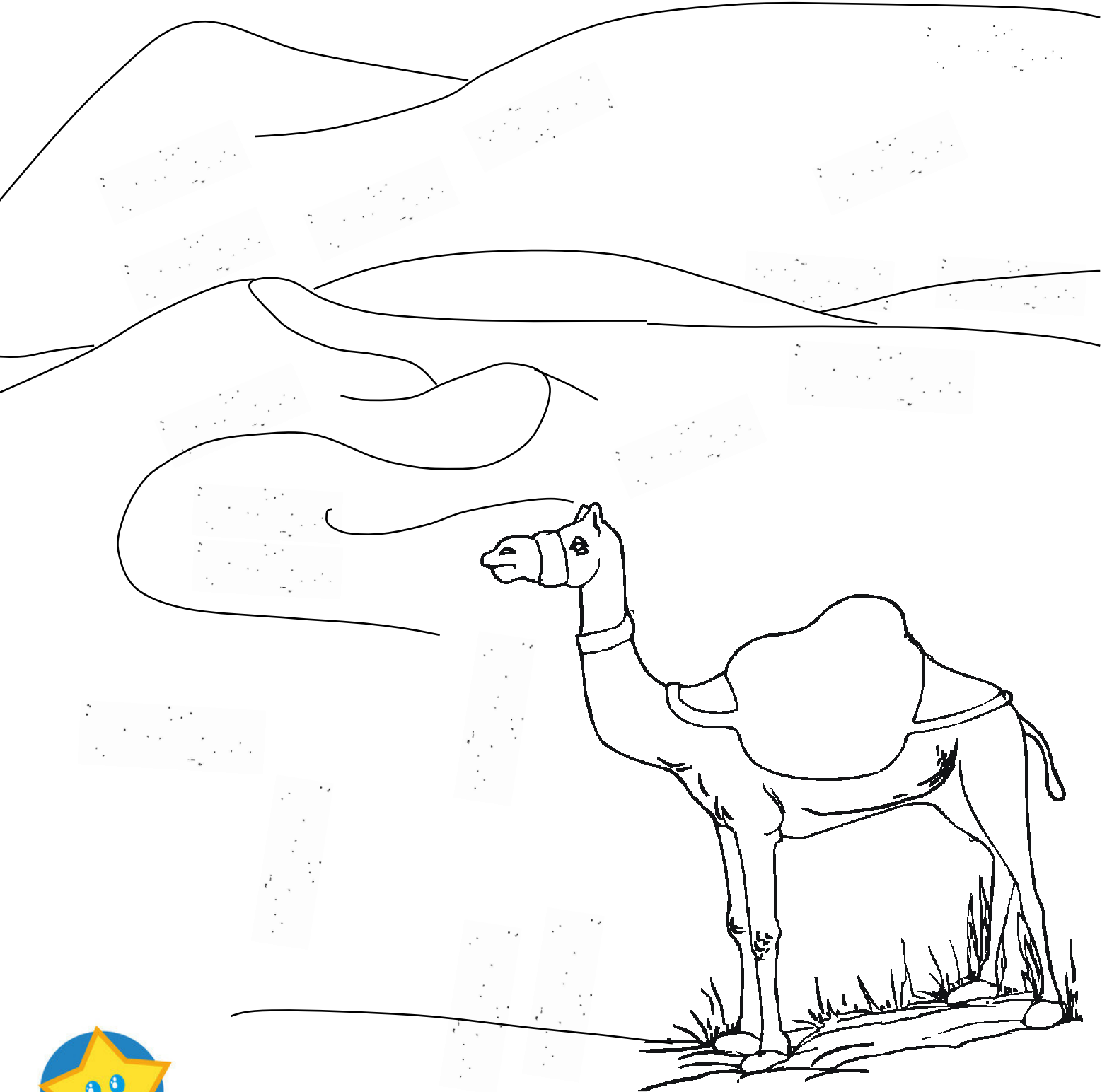

أطابق الصور وأصل.

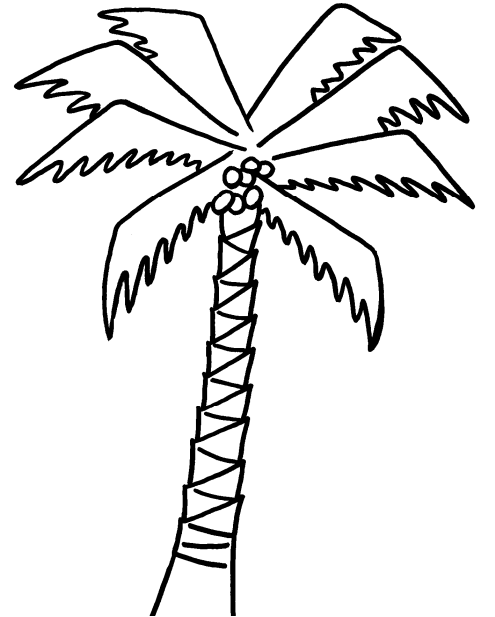

" ثقيل ، خفيف " أحوِّط الشيء الخفيف.



جرّة

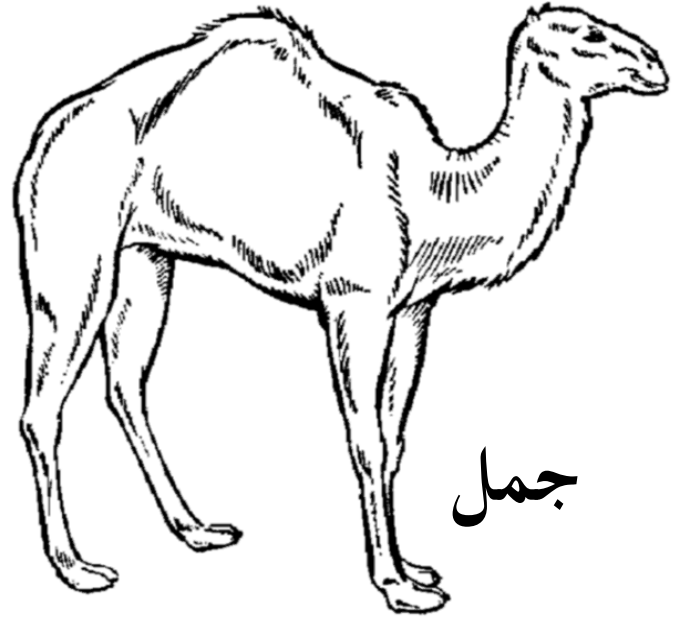

جمل

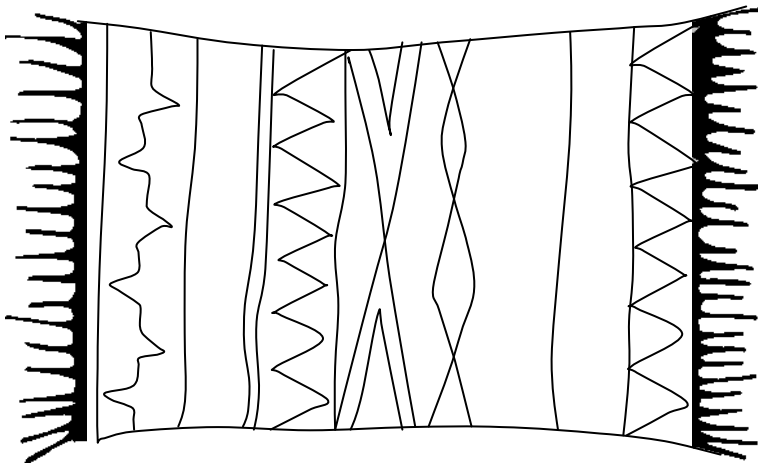

سجادة

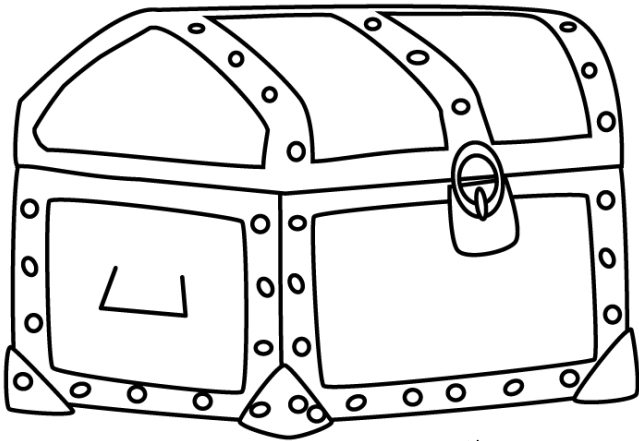

صندوق

رمل

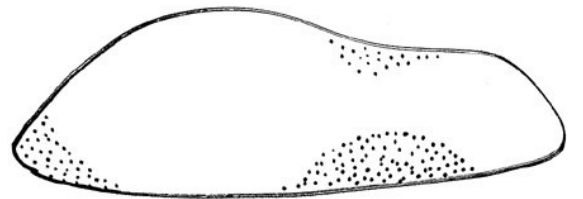

وحدة

الحج



ملابس الإحرام. ألون.

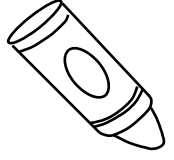

ملابس الإحرام

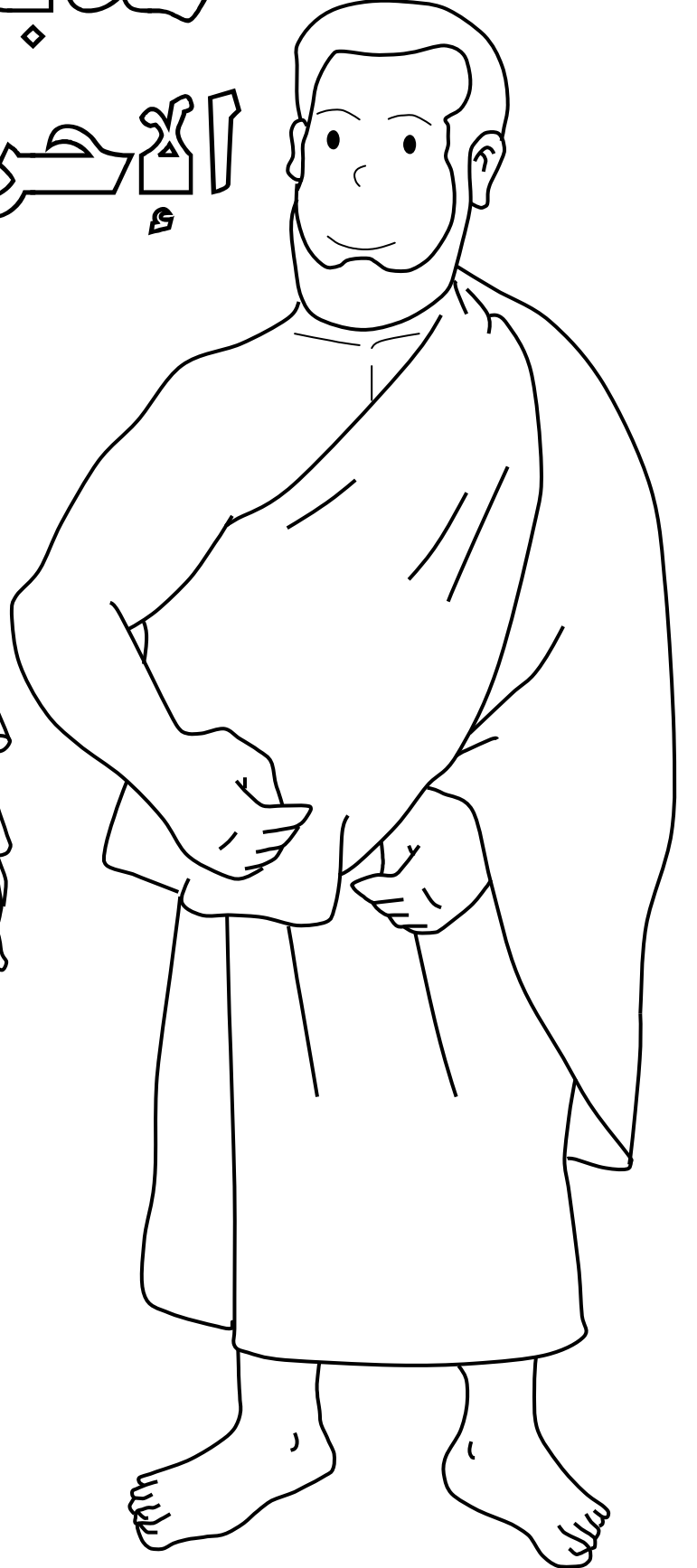

طرق سفر الحجاج. أخطط.

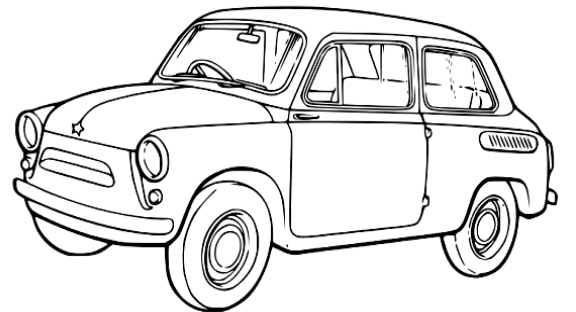
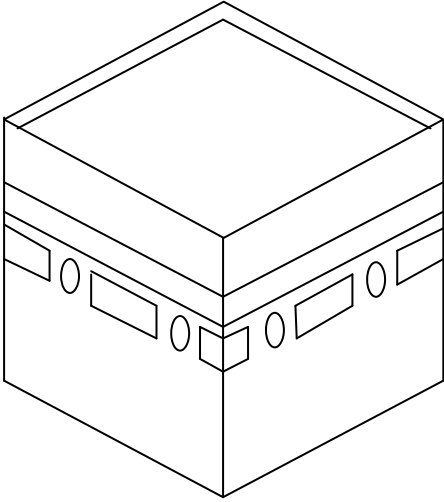
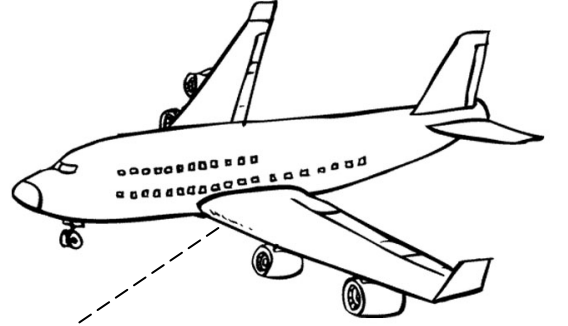

أحوط هدايا الحجاج.

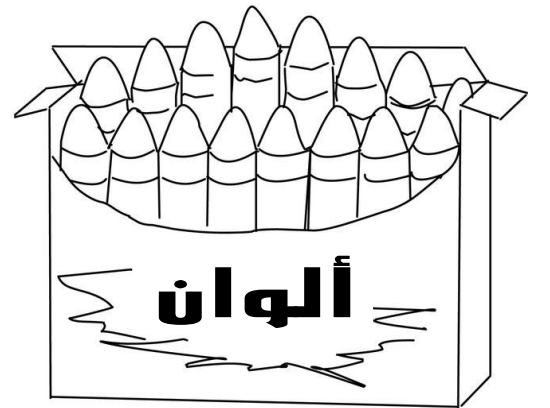
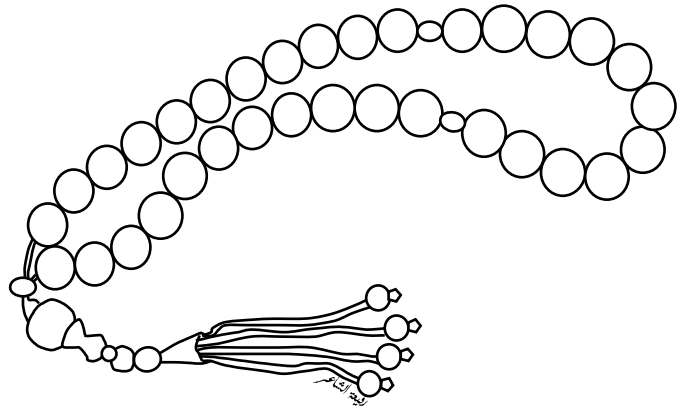
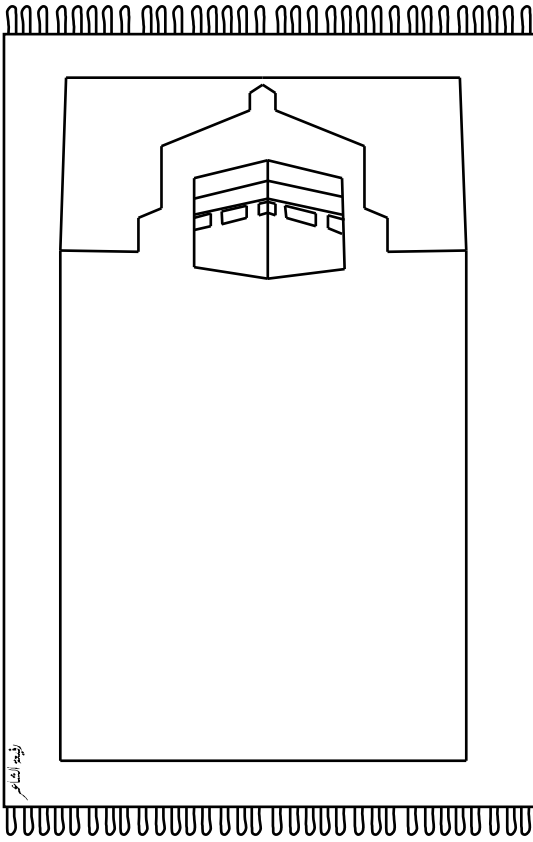
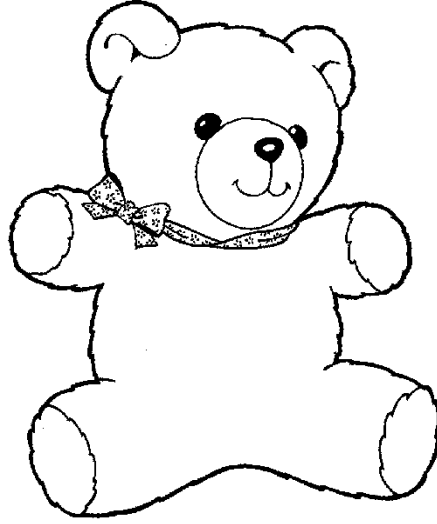
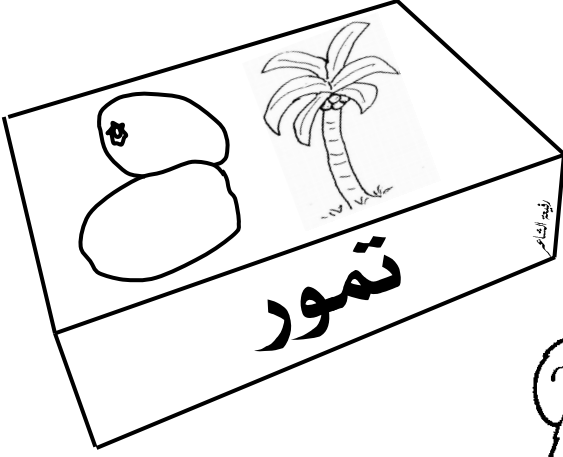

أتعرف على مظاهر الاحتفال بالعيد و ألون.

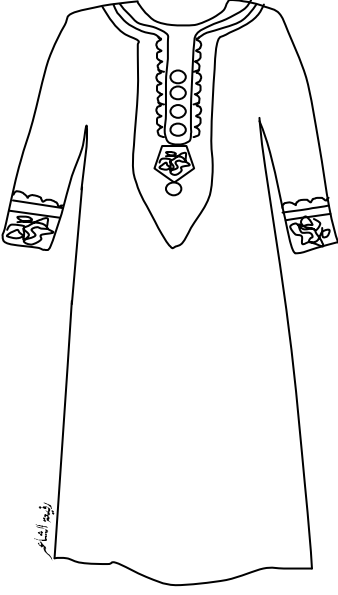

ملابس العيد

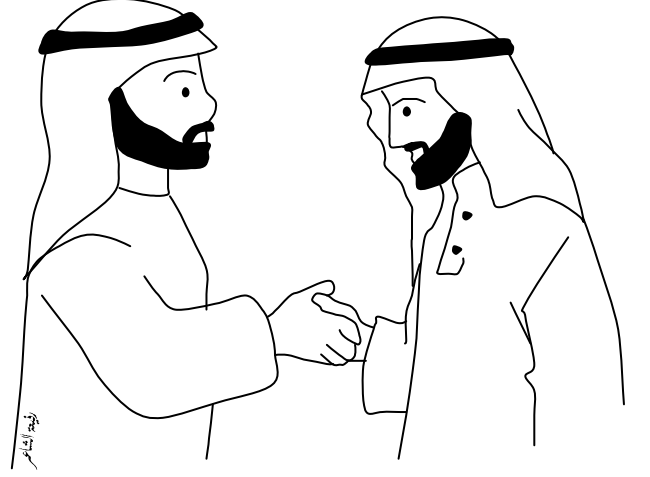

زيارة الأهل والأقارب

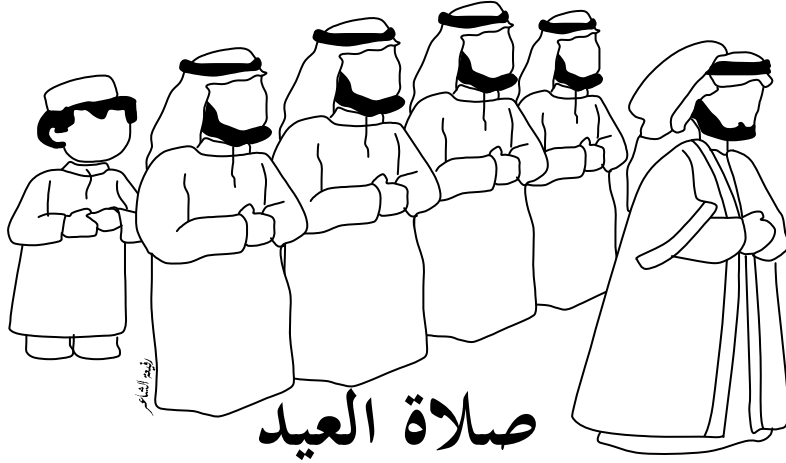

صلاة العيد



الرقصات الشعبية

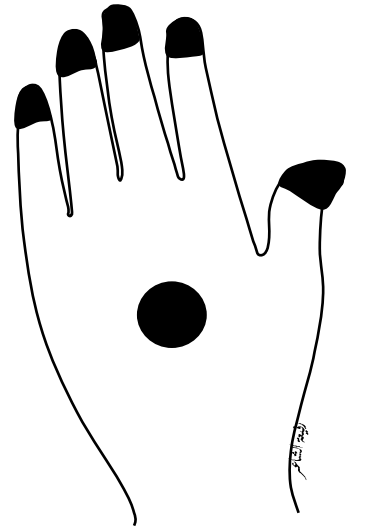

نقش الحنا



العيد فرحة.

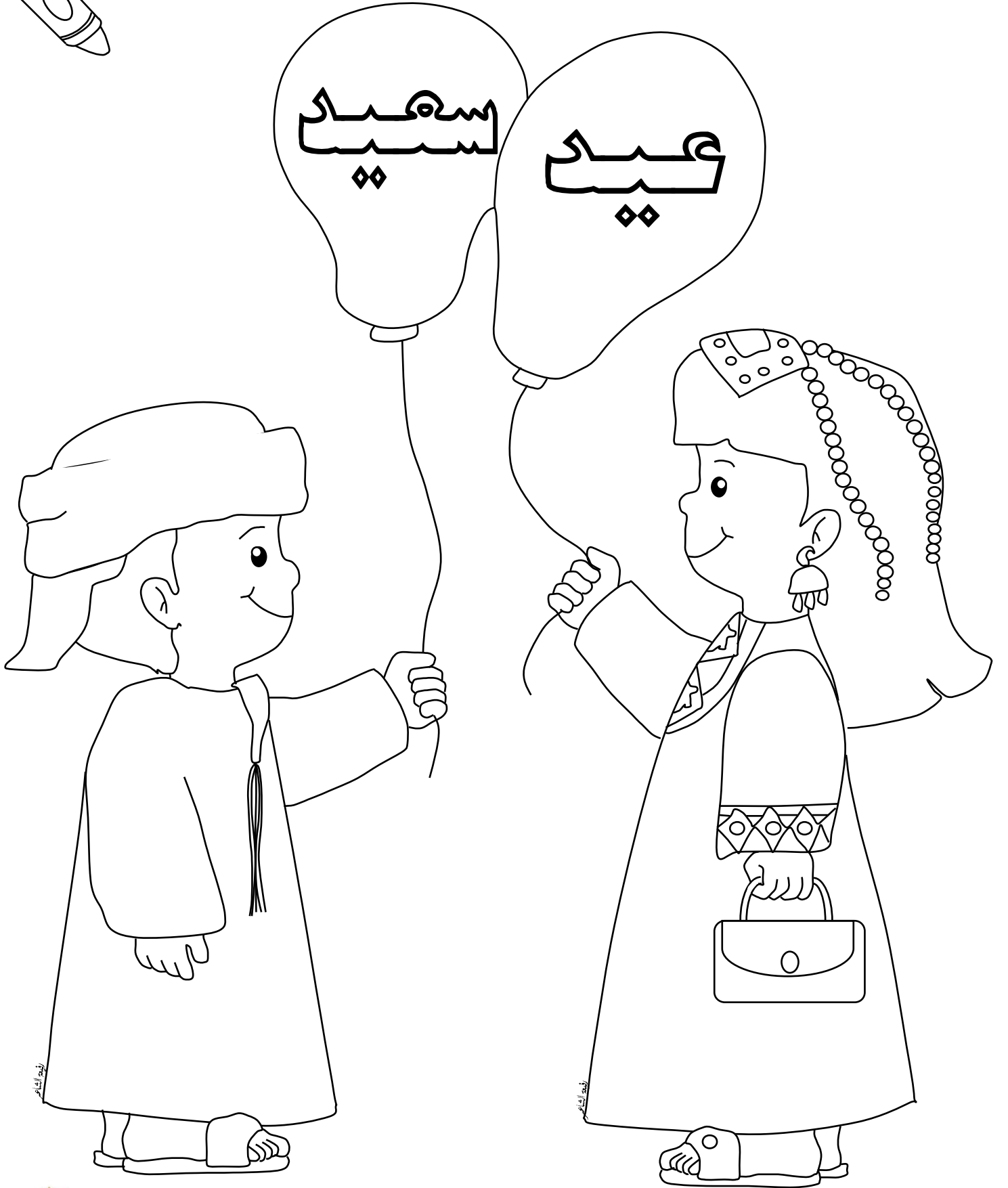
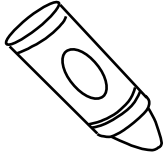

تسلسل الأحجام، أصل الأحجام المتساوية مع بعضها البعض.

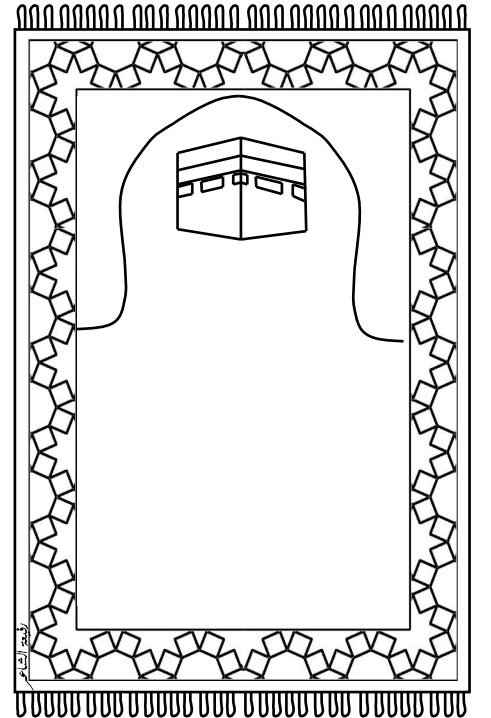
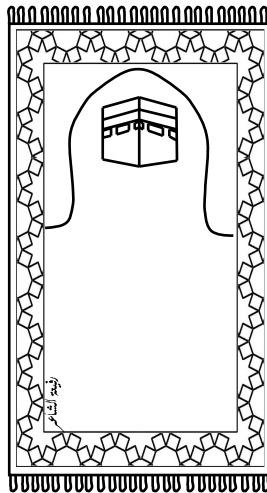
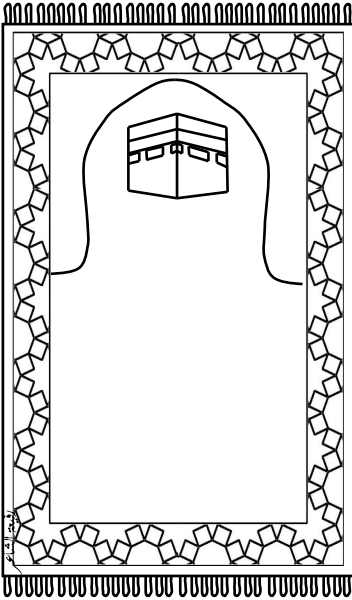
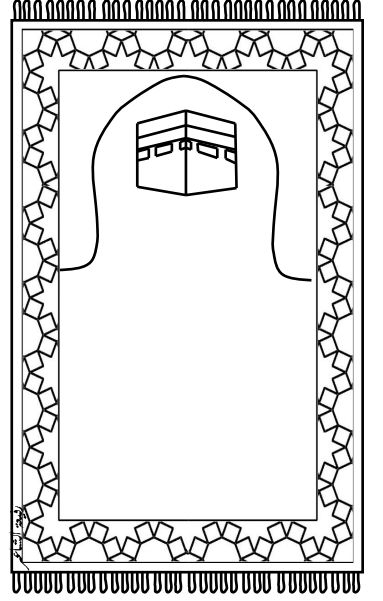
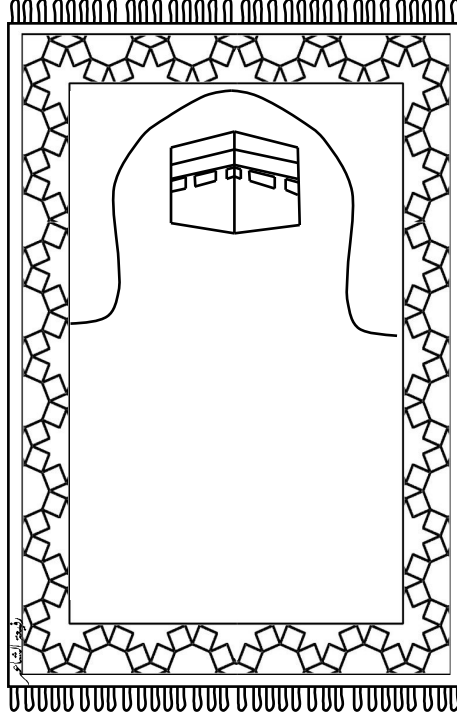
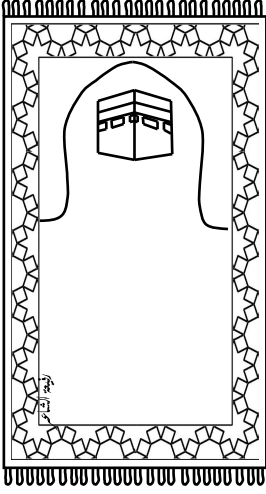

وحدة

النباتات



أبحث عن صور نباتات والونها.

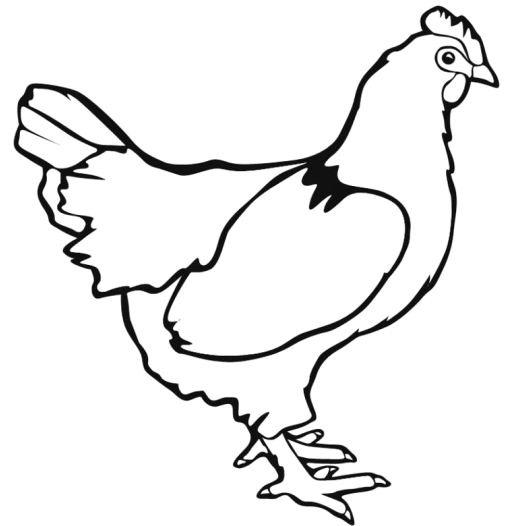
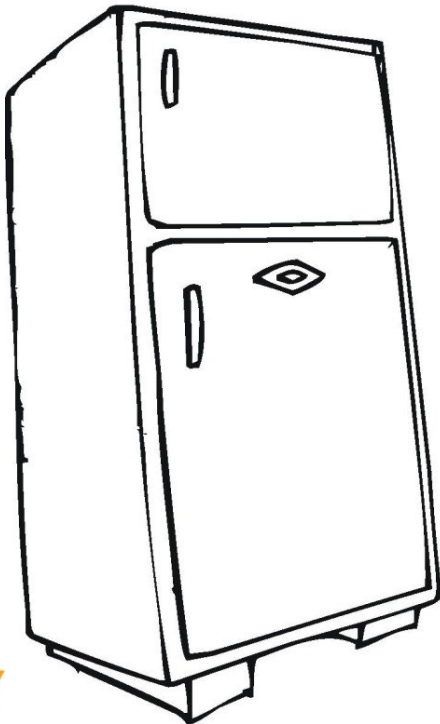
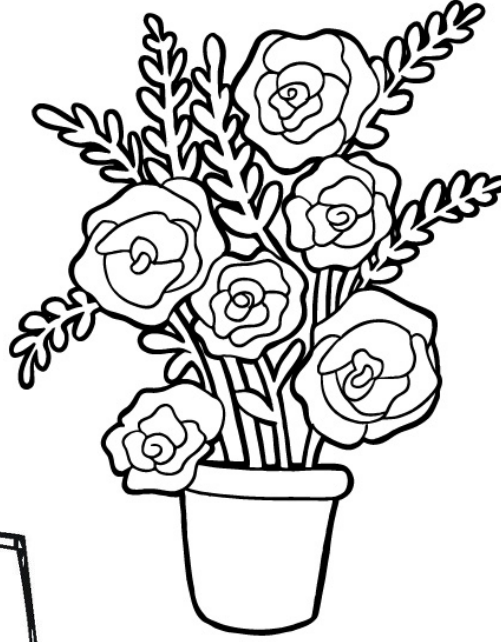
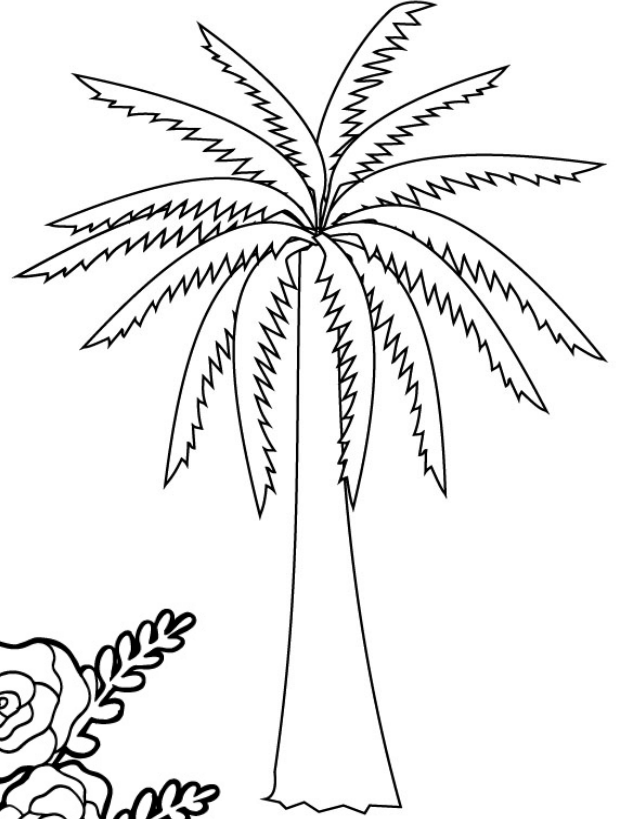
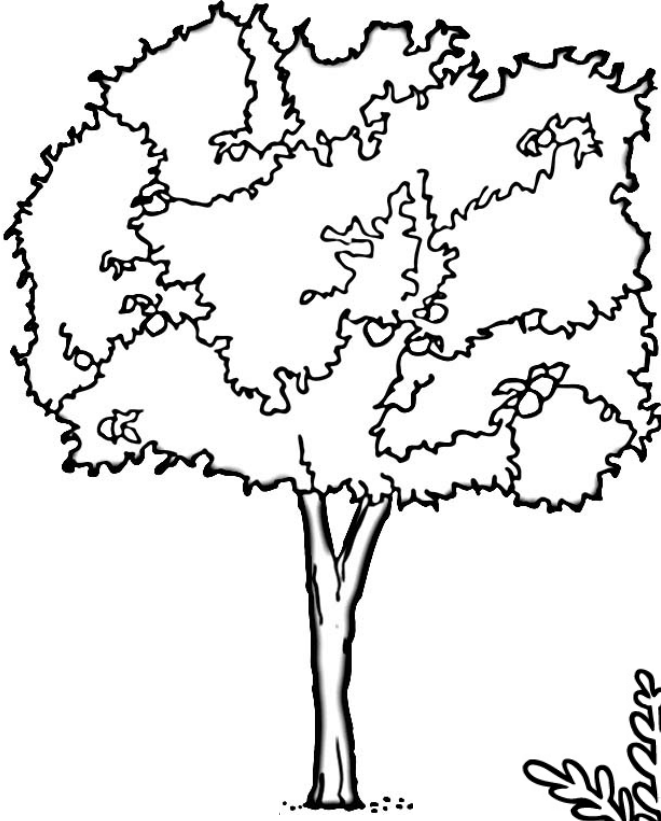

النباتات

وحداتي

نصنع من النخلة منتجات عديدة، أصل النخلة بمنتجاتها وفوائدها.

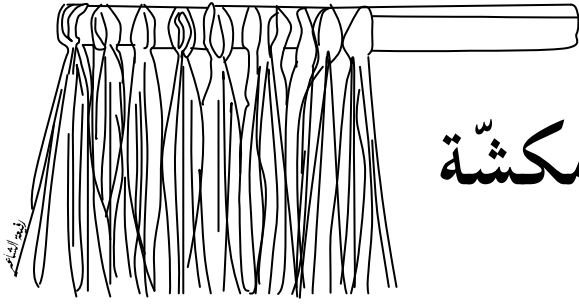

مكشّة

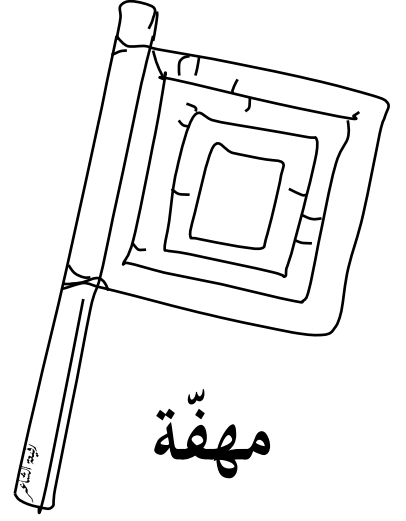

مهفة

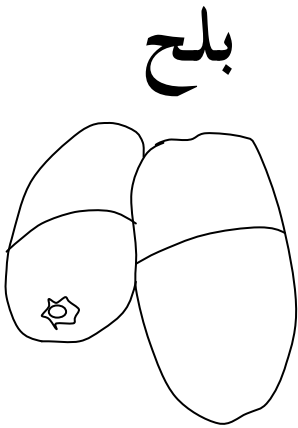

بلح

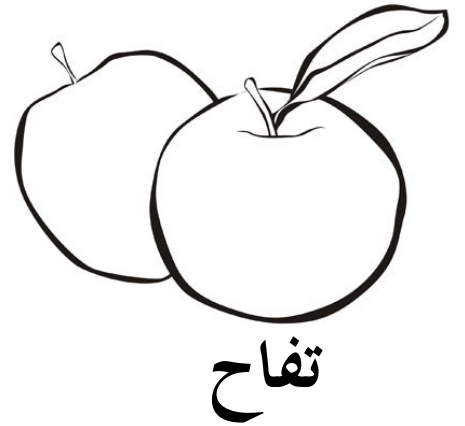
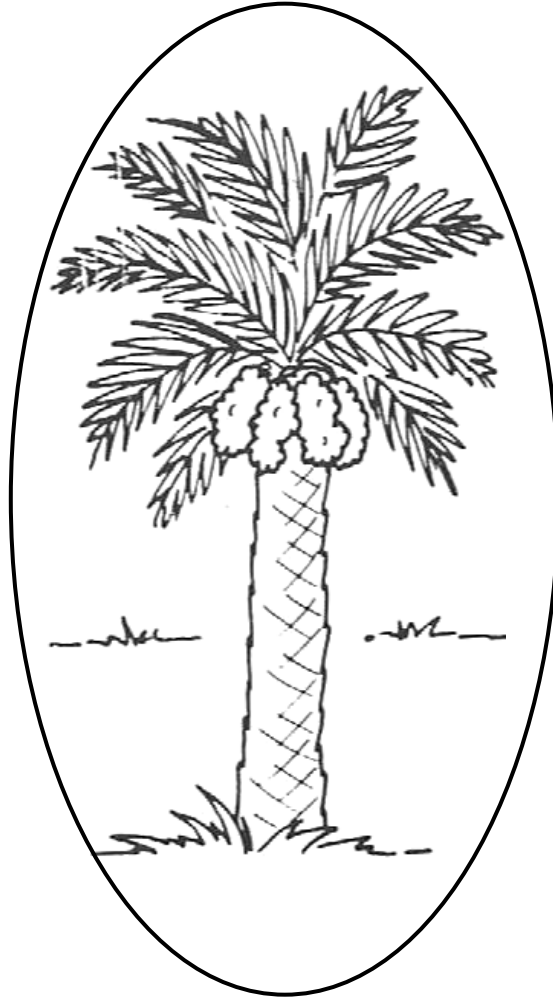

تفاح



أزهار



مخرافة



أوراق النباتات مختلفة، أطابق وأصل.

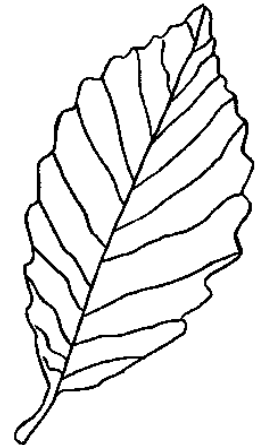
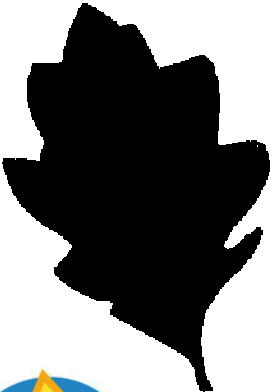
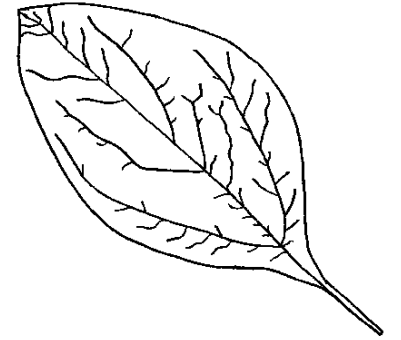
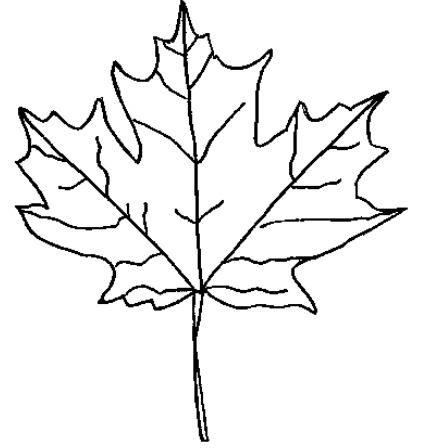
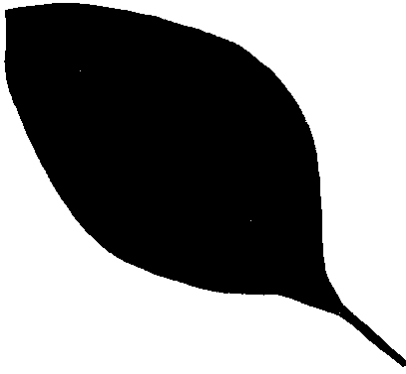
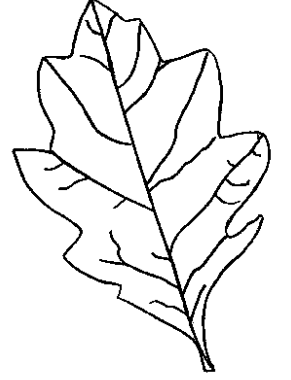

للنباتات بذور، أكتشف بذور بعض الفواكه وألونها.

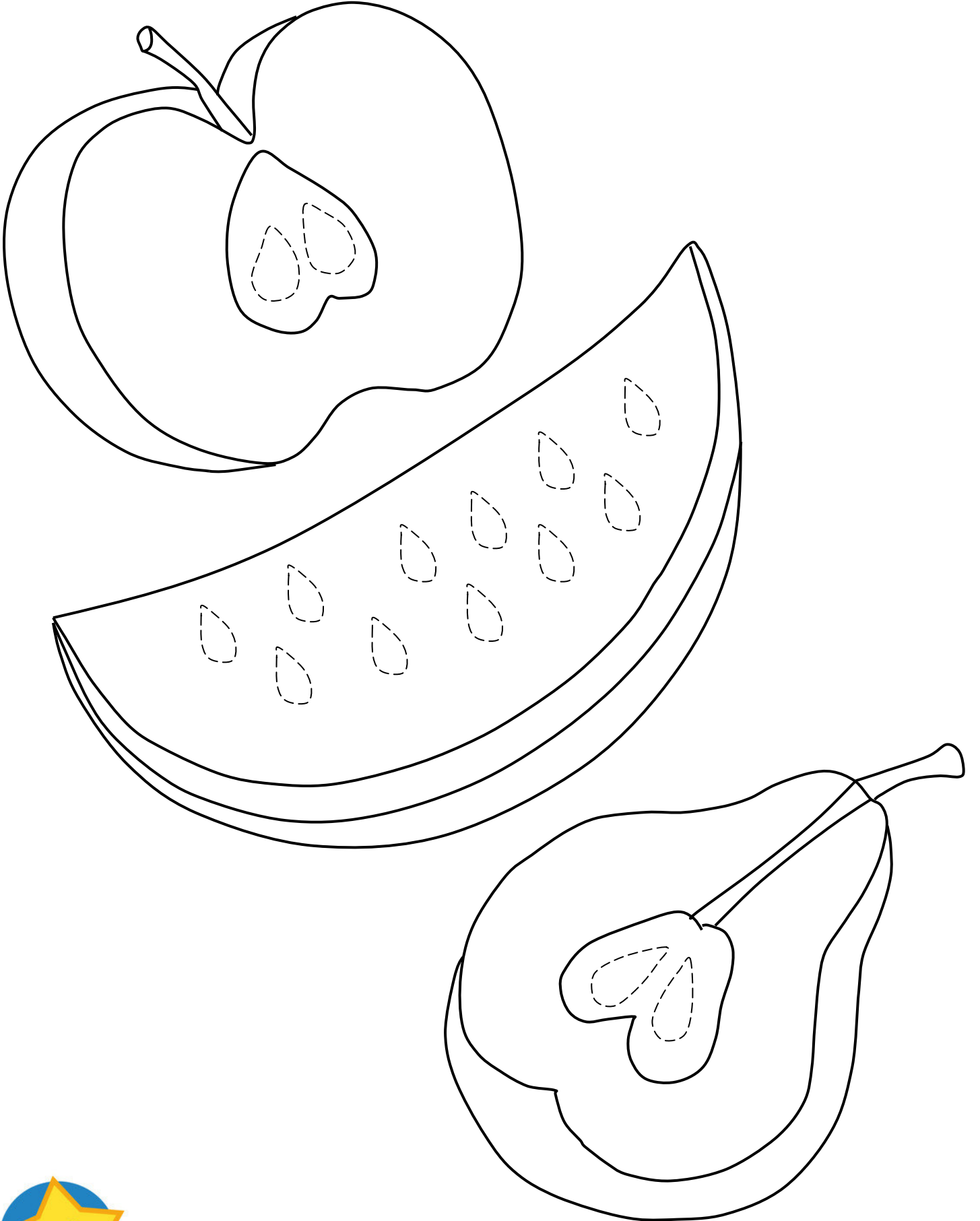

وحدة

الماء



استعمال الماء، ألون صور الأشخاص الذين يستخدمون الماء.

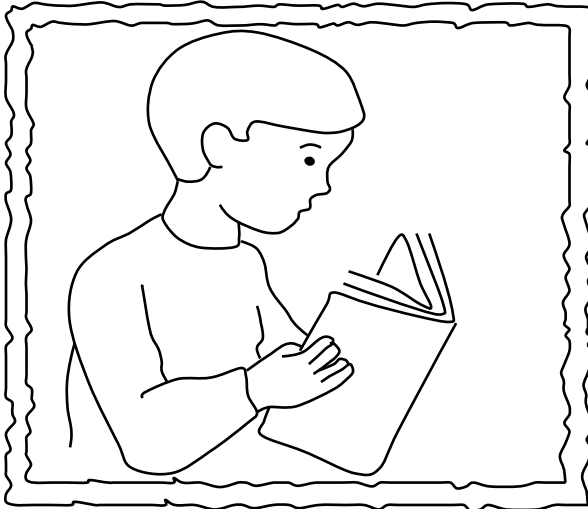
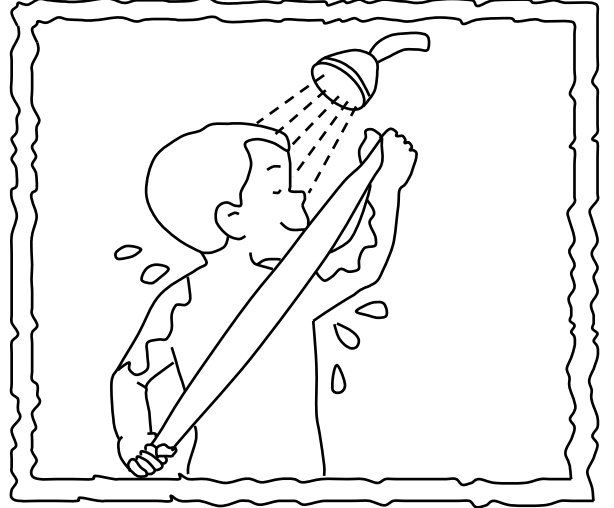
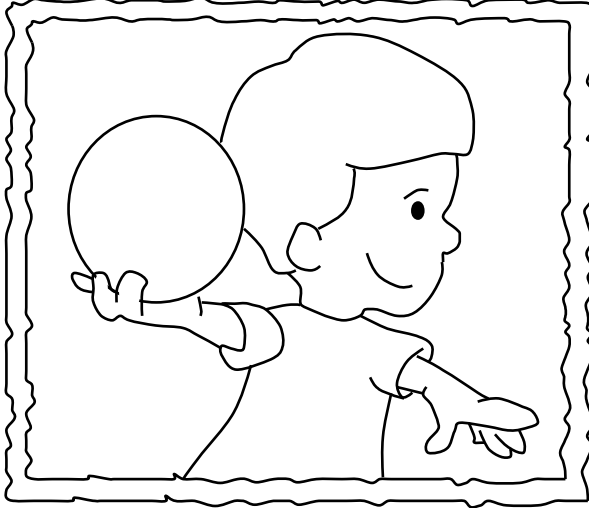
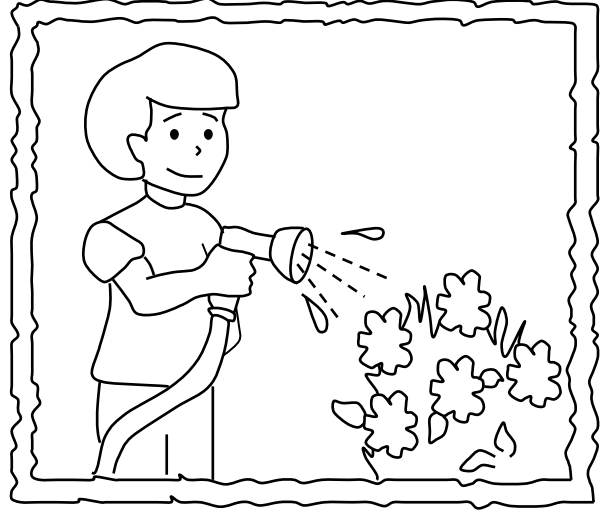
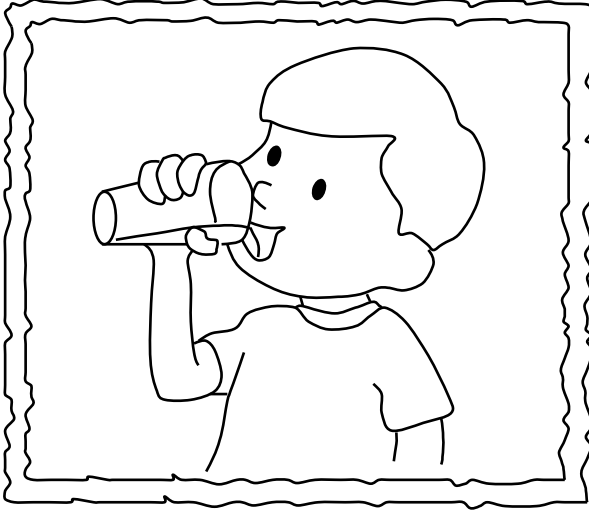

أتعرف على مصادر المياه.



مطر

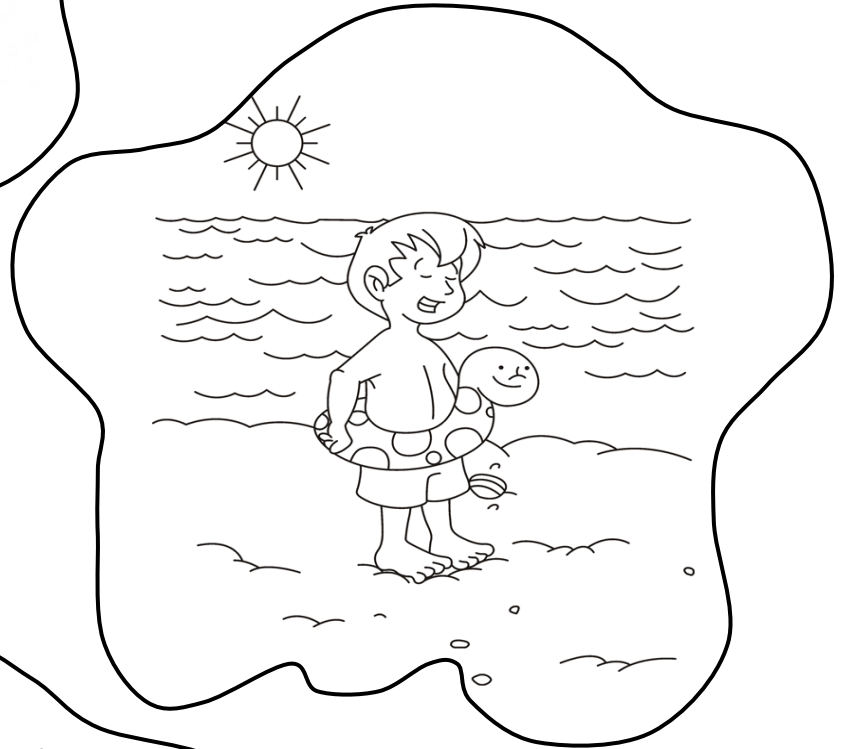

بحر

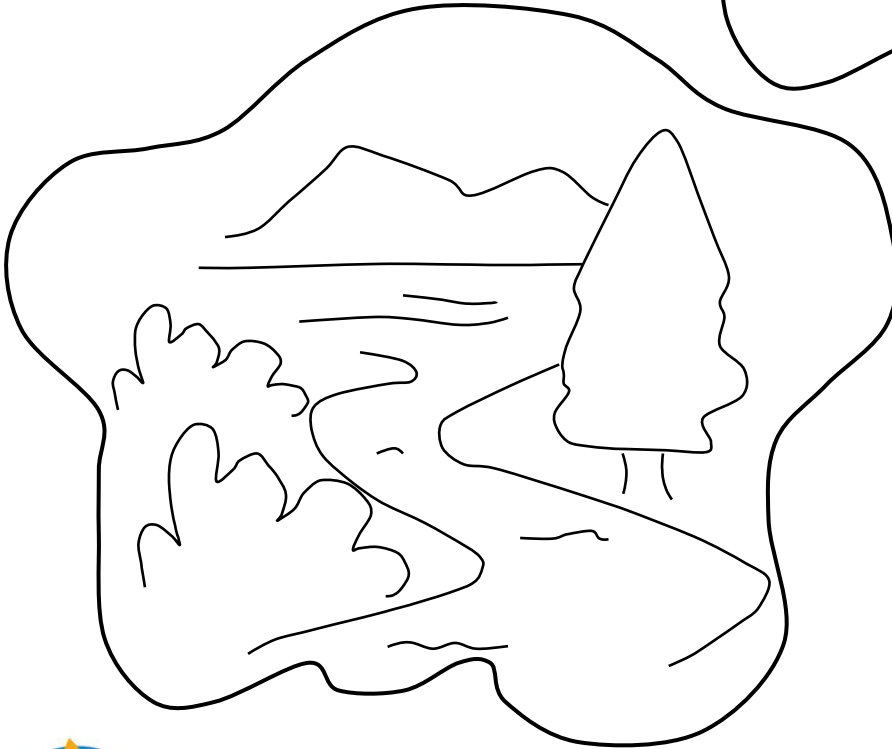

نهر



أحوط الكائنات الحية التي تحتاج إلى ماء كي تعيش.

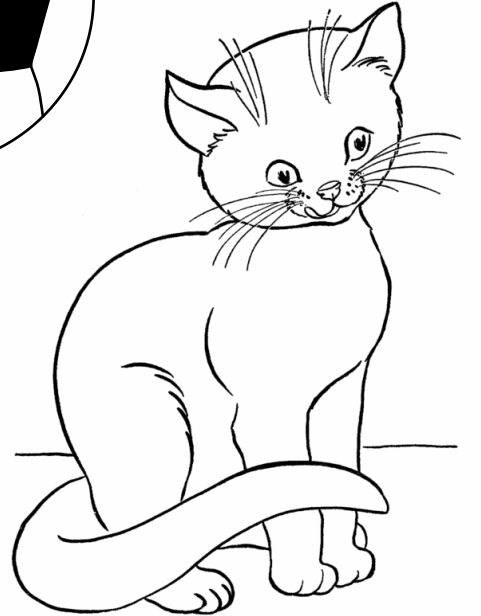
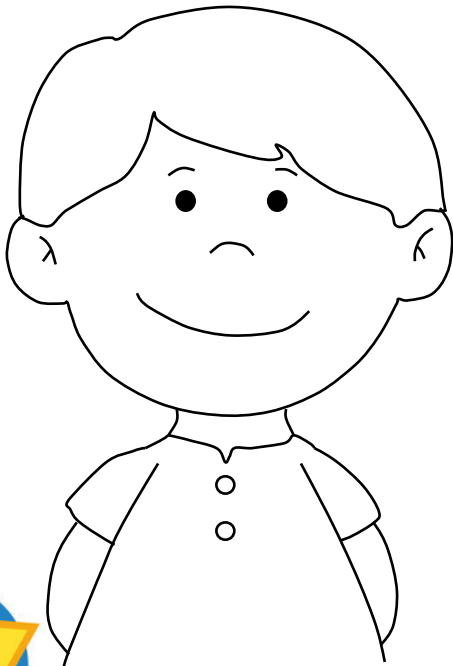
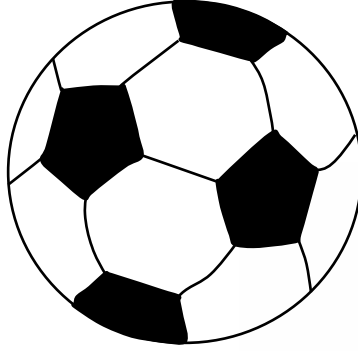
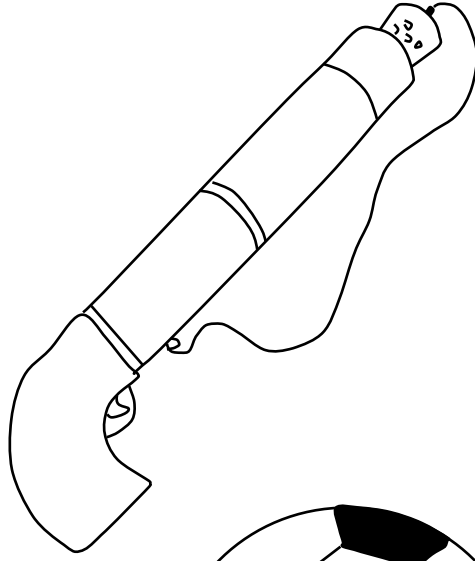
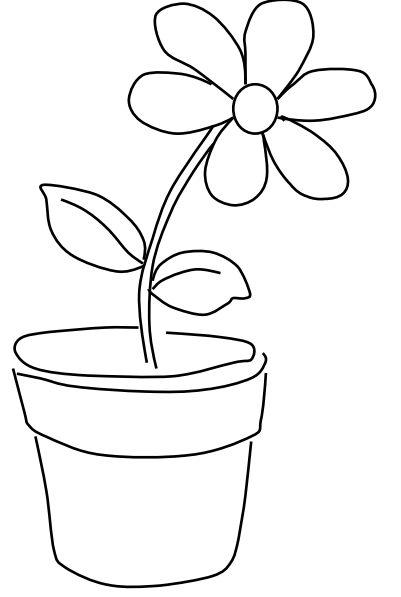
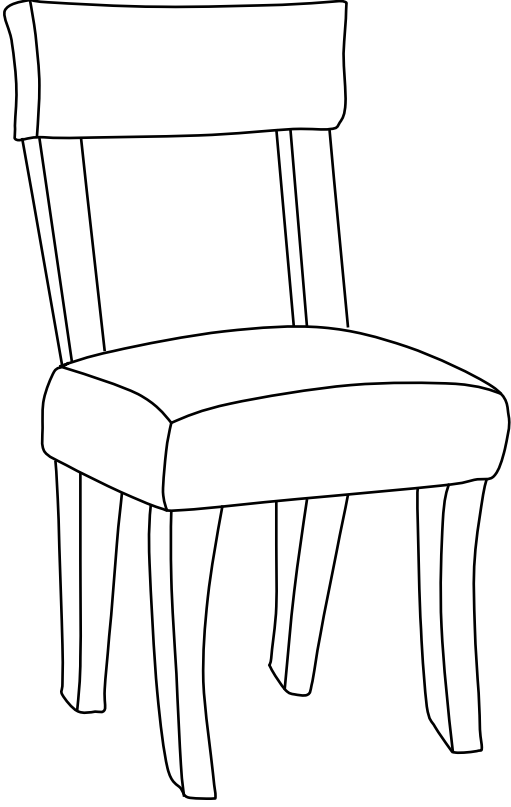

الكائنات البحرية.

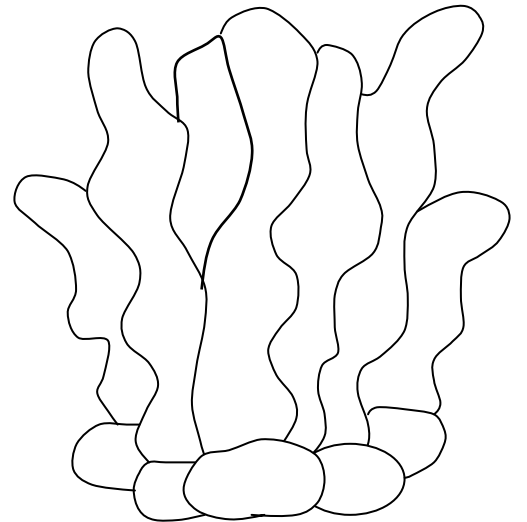
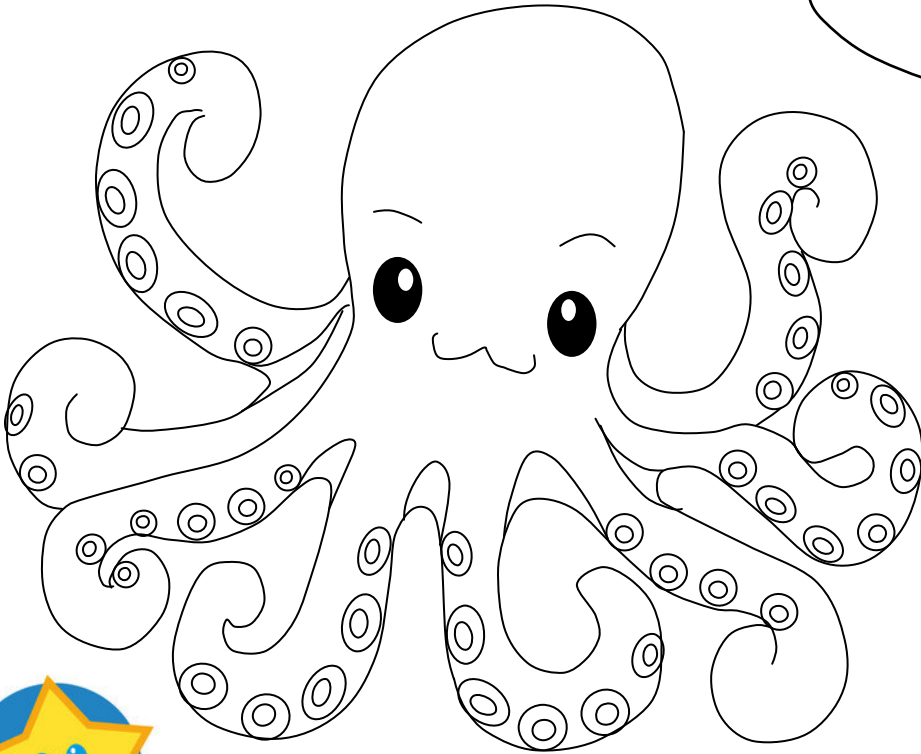
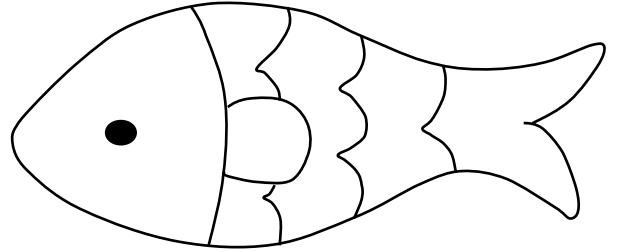
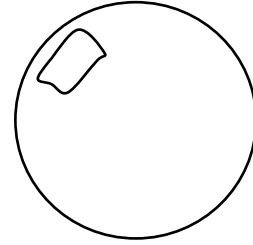
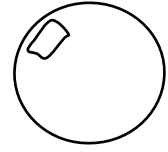
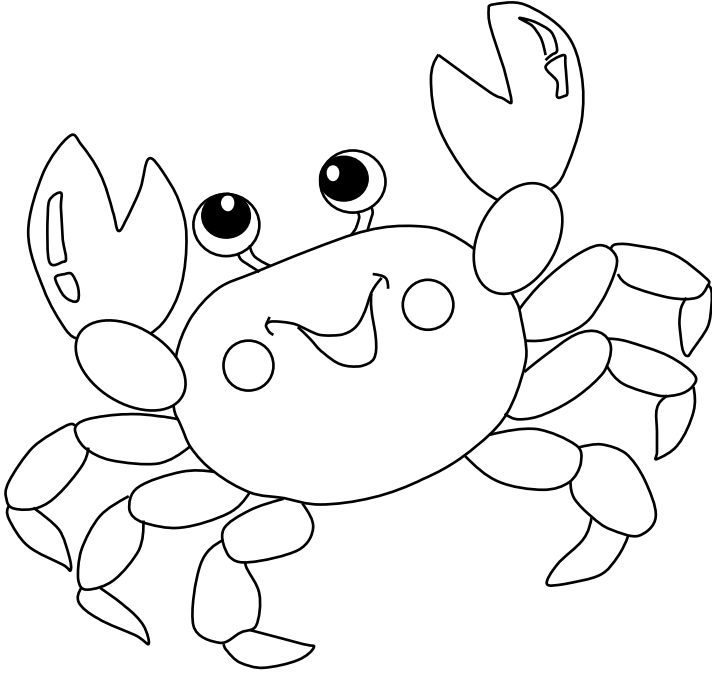
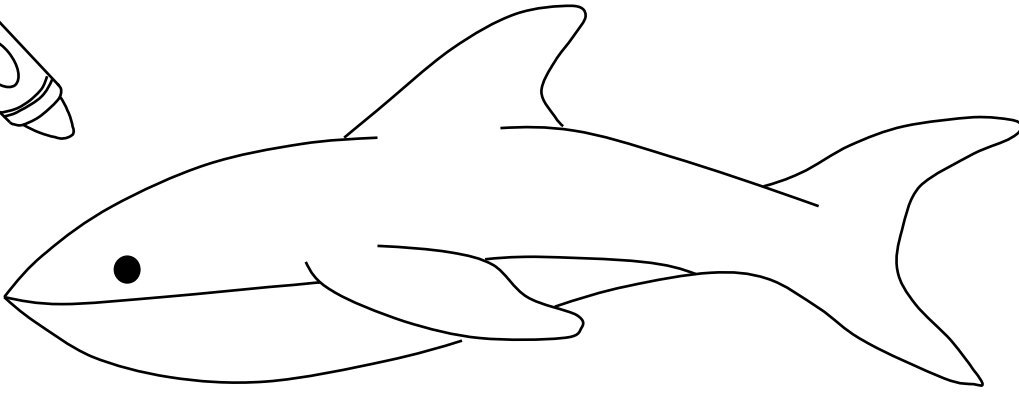
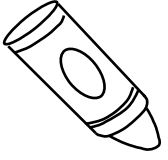

وحدة

المواصلات



أصل وسيلة المواصلات بالمكان المناسب.

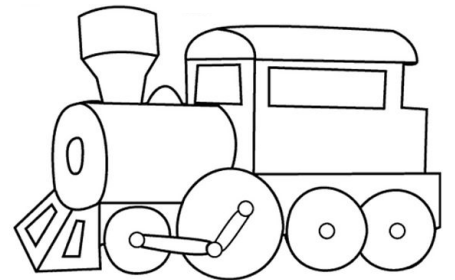
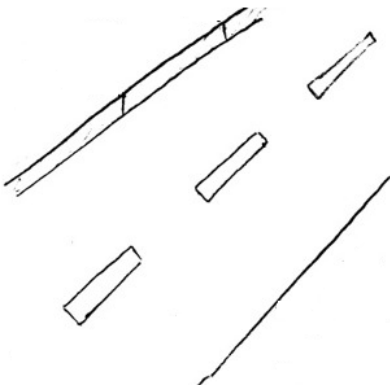
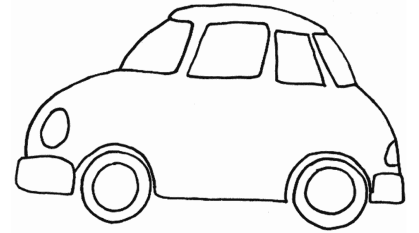
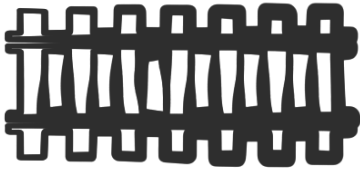
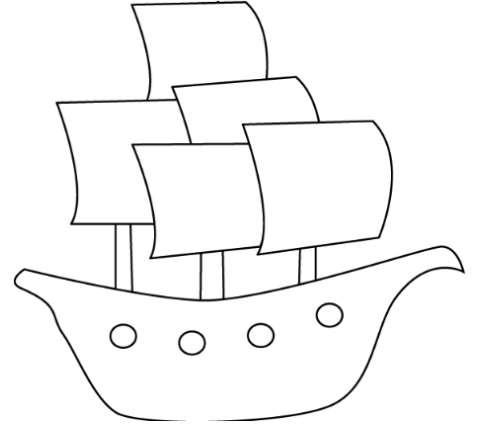
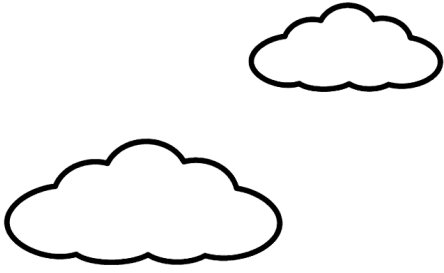

للسيارات ألوان وأحجام ، أطبق وأصل.

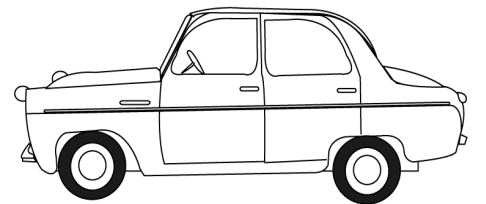
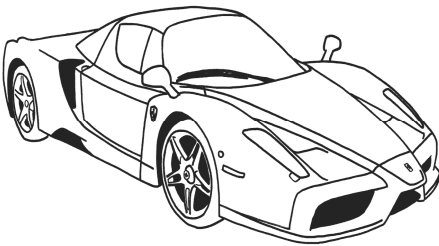
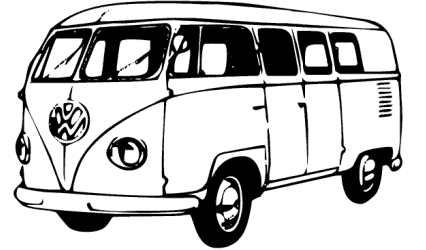
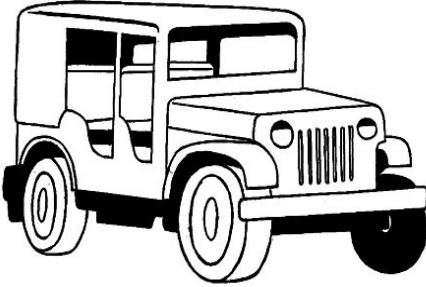
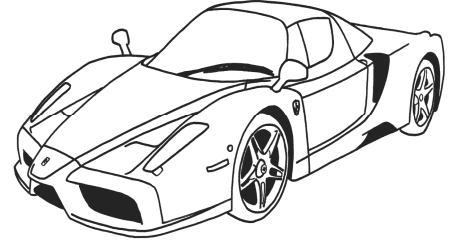
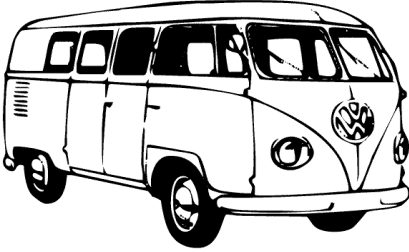
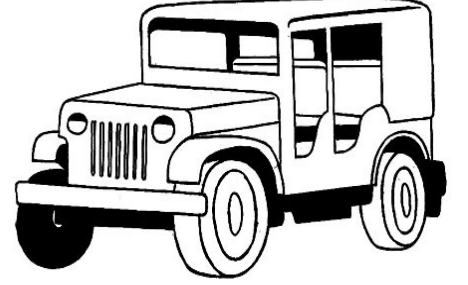
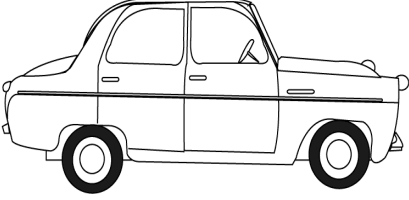

أبحث عن أربعة أجزاء للسيارة وأحوظها.

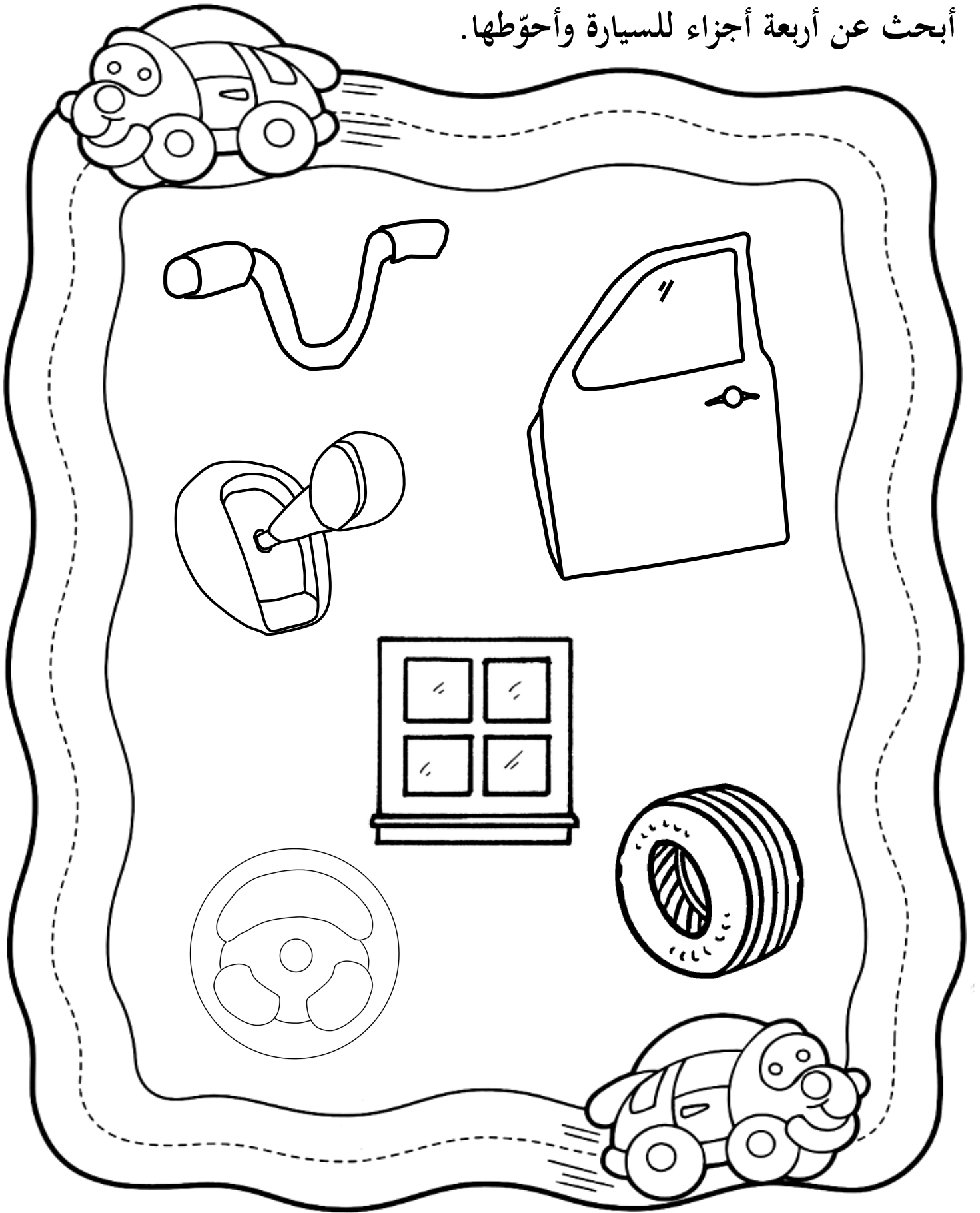

ألون الوسيلة التي تساعدني في الذهاب إلى روضتي.



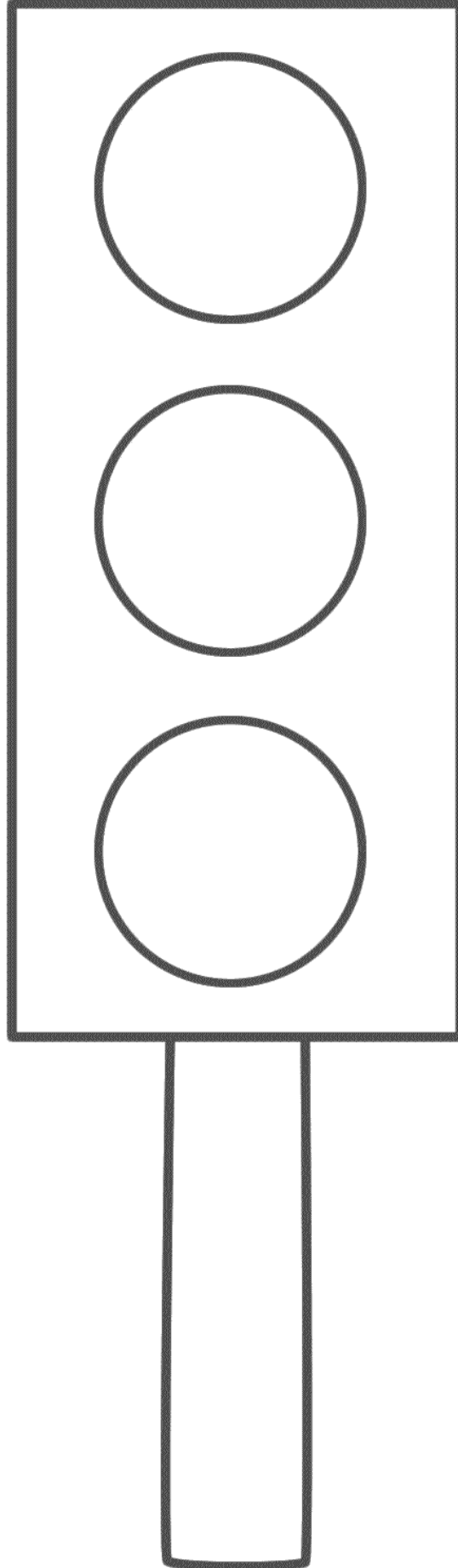
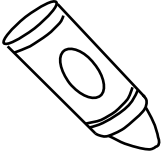

ألوان
إشارة
العبرور





وحدة

السيرة النبوية



أخطط على اسم نبينا محمد ﷺ

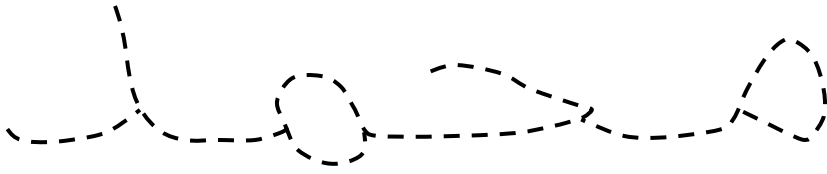
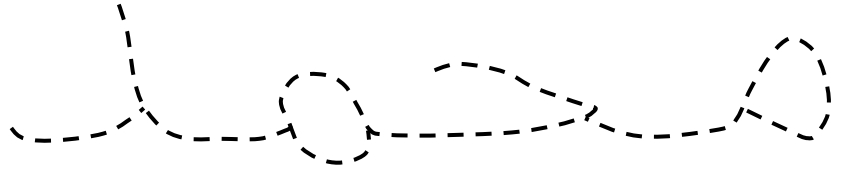
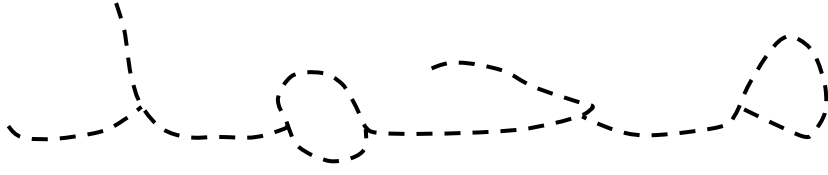

صلى الله عليه وسلم

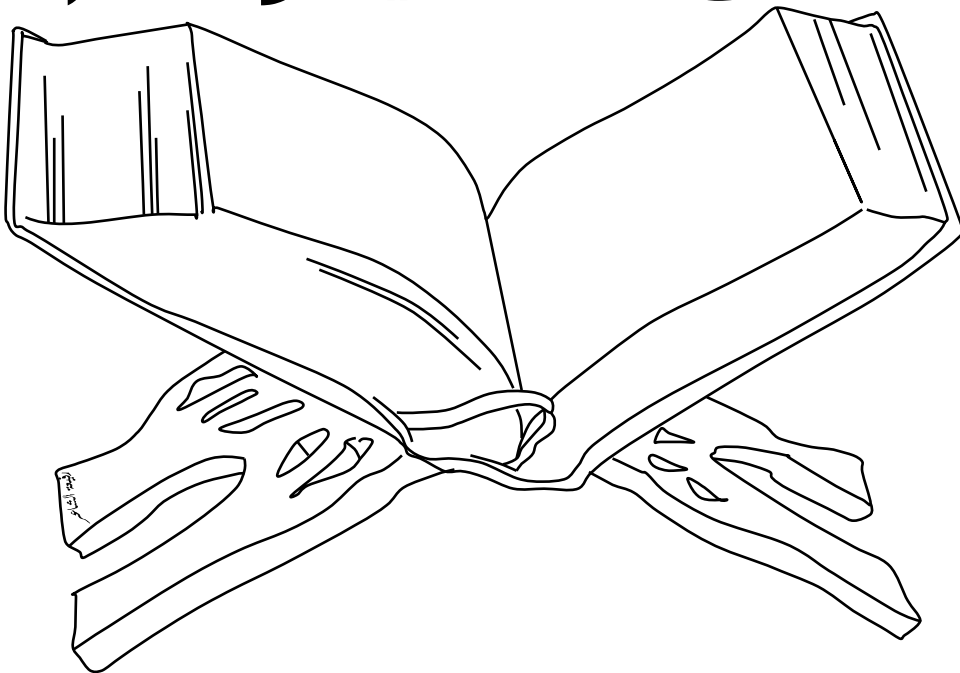

أطابق وأصل.

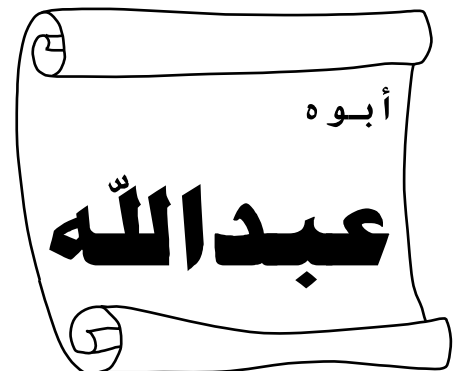
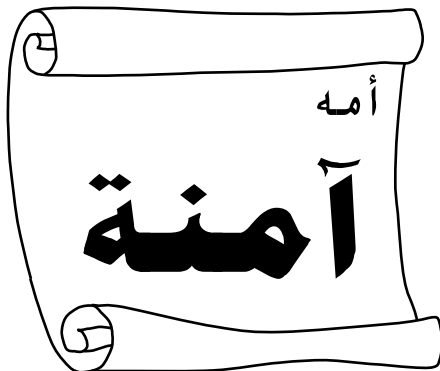
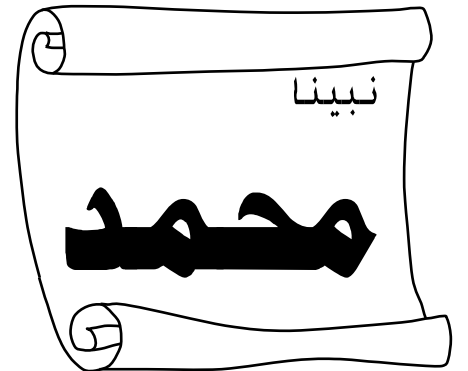
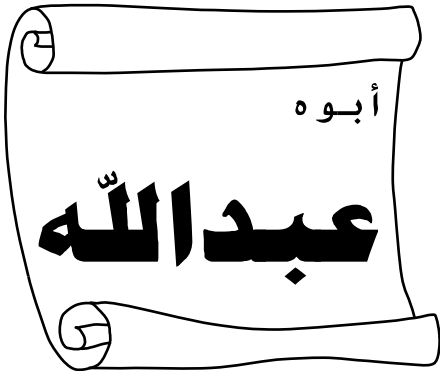
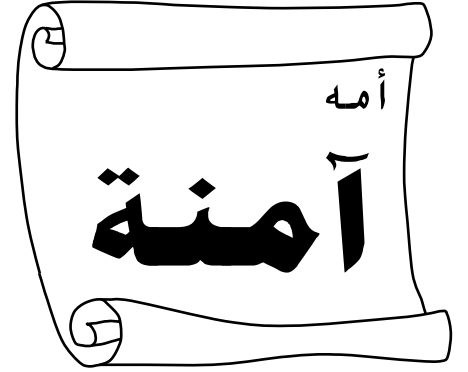
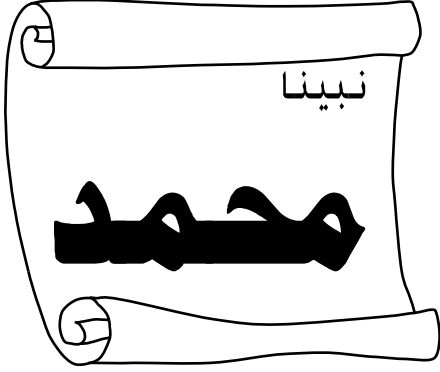

ماذا اشتغل الرسول ﷺ وهو صغيراً؟ ألون إجابتي.

النجارة

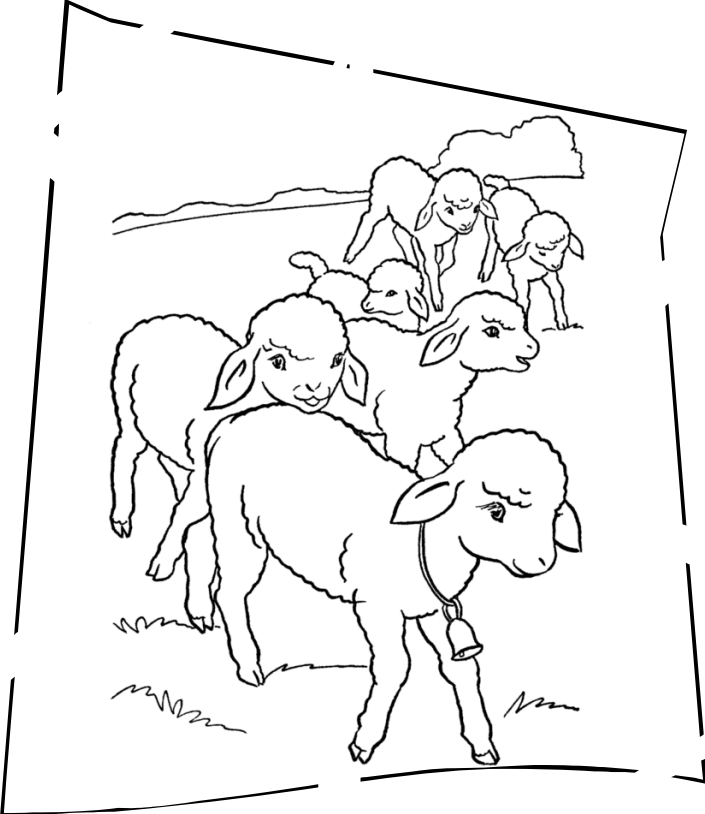
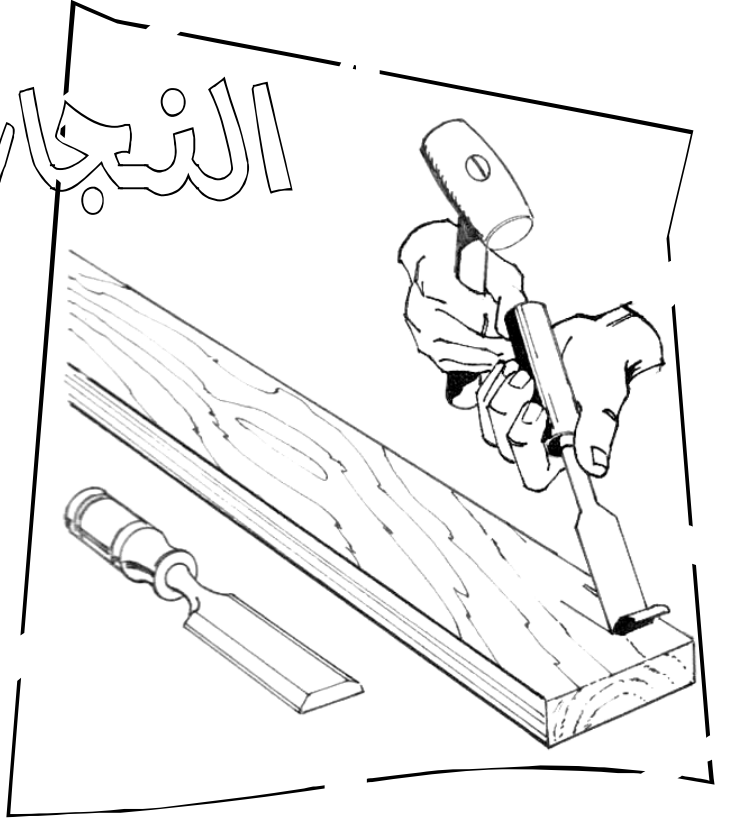

رعي الغنم

المصيد

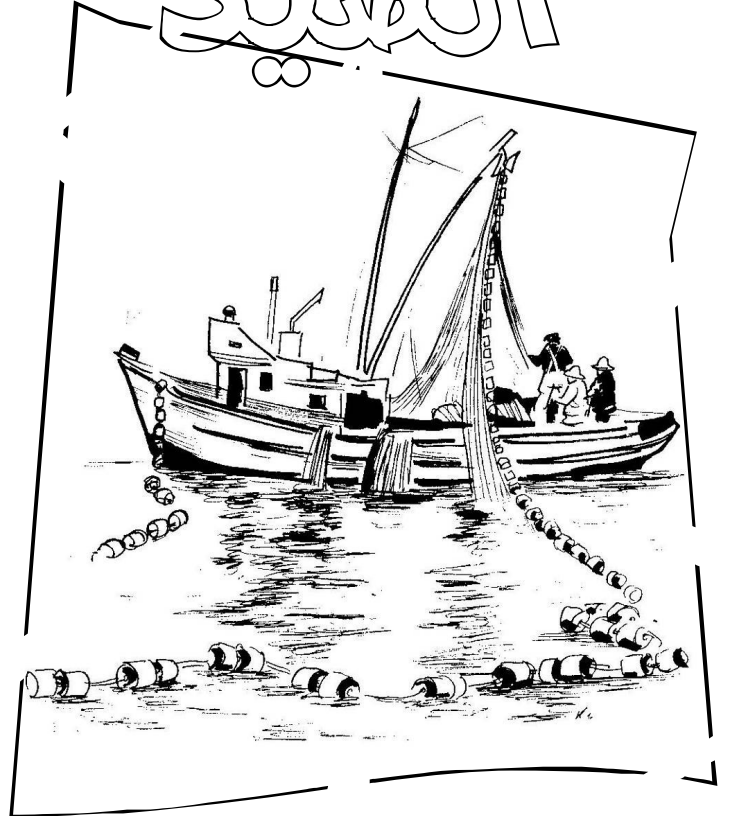

ألون صفات حبيبنا رسول الله ﷺ

الصدق

الأمانة

الكرم



العطف على الفقر، ألون الصورة التي تدل عطف مروان على الفقراء.

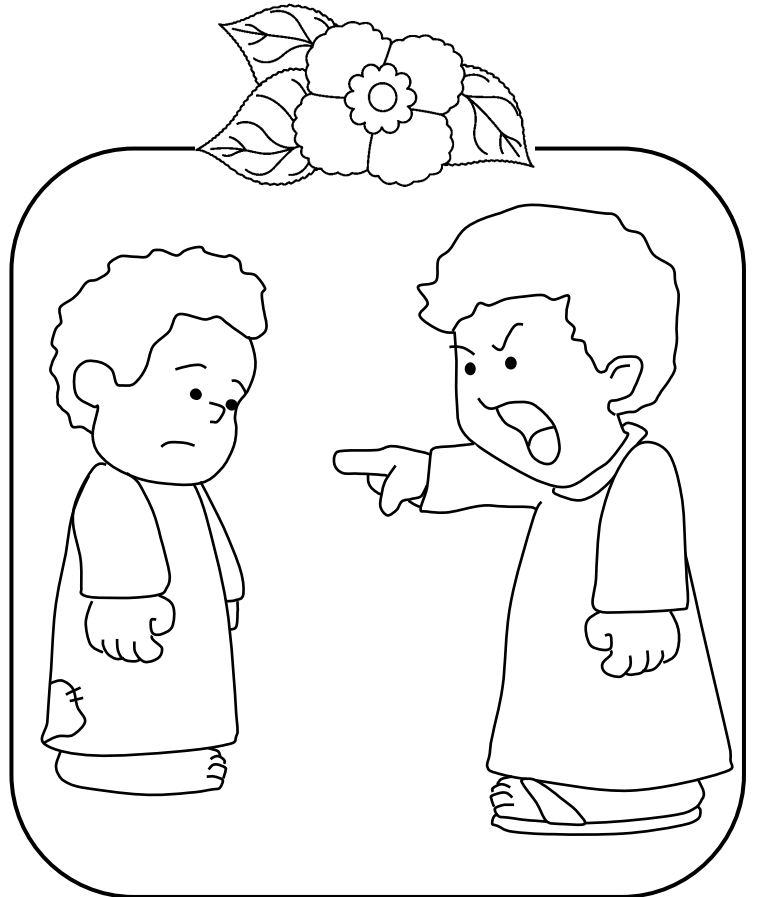
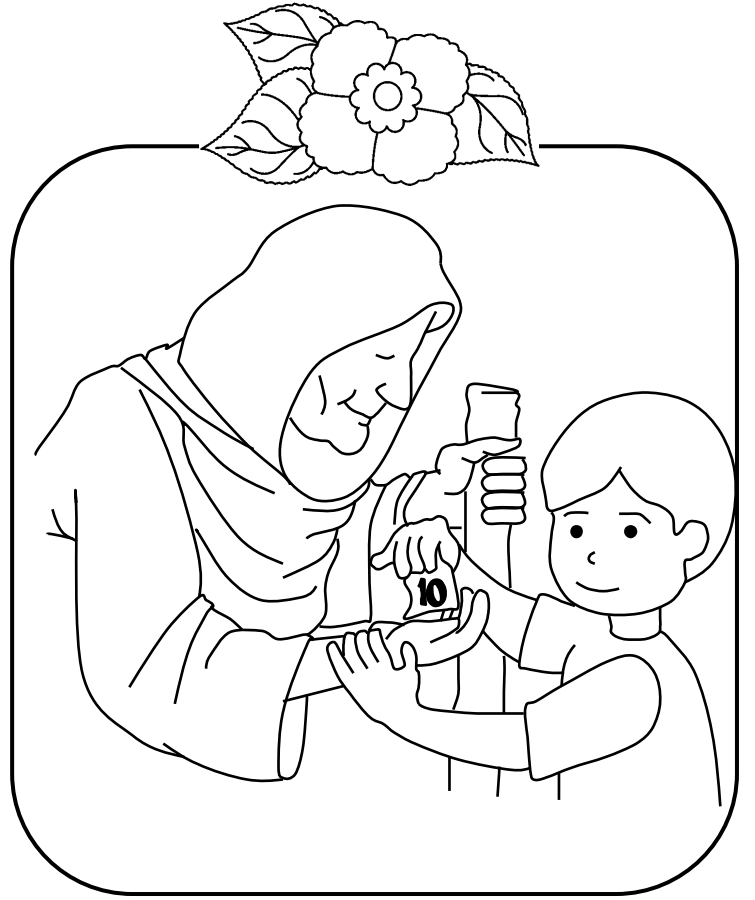
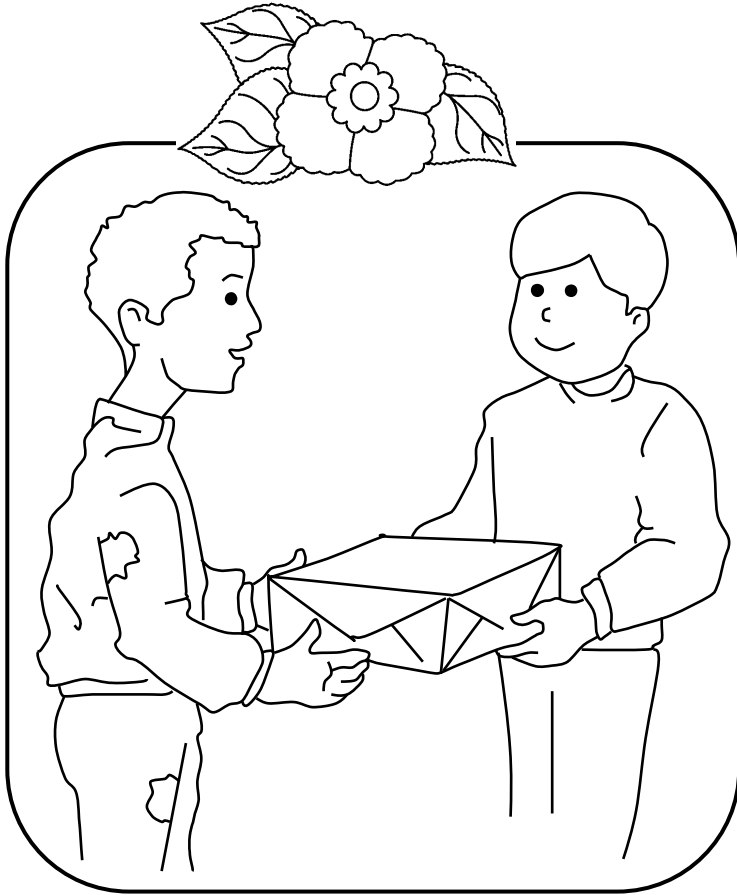

وحدة

السياحة



معالم بلادي كثيرة. أطابق وأصل.

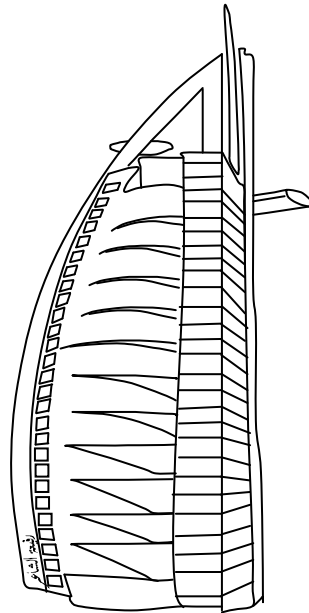
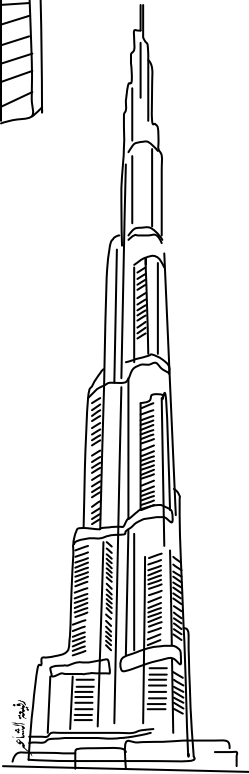
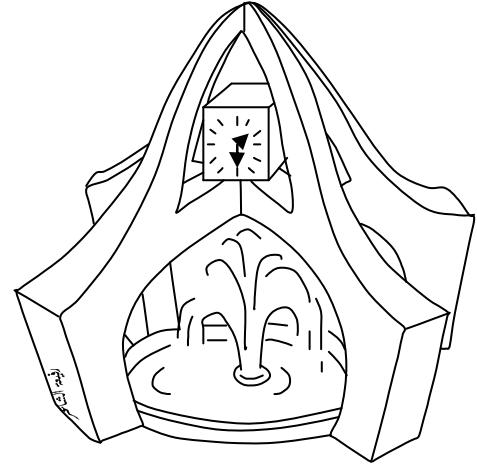
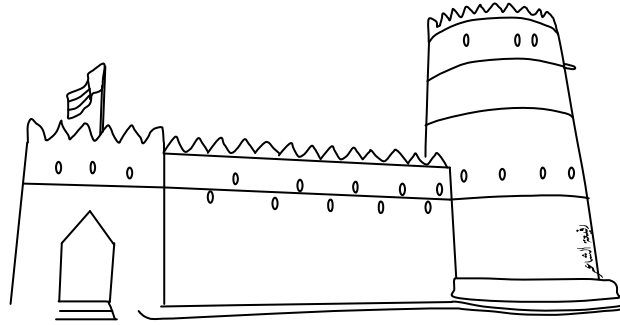
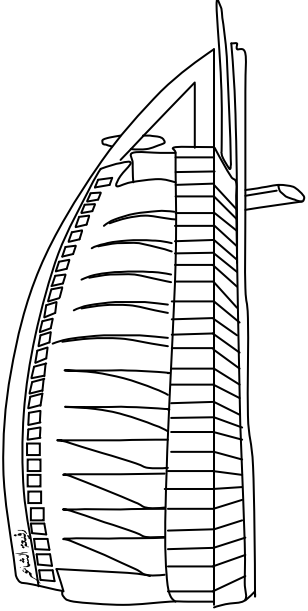
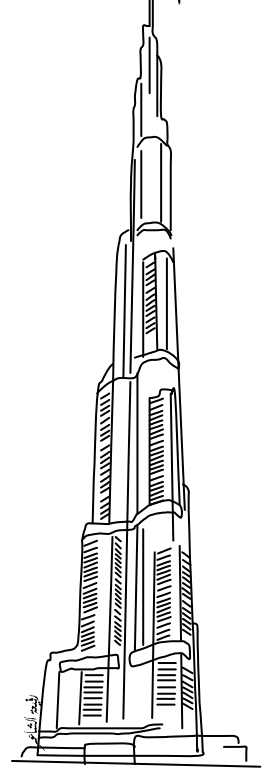
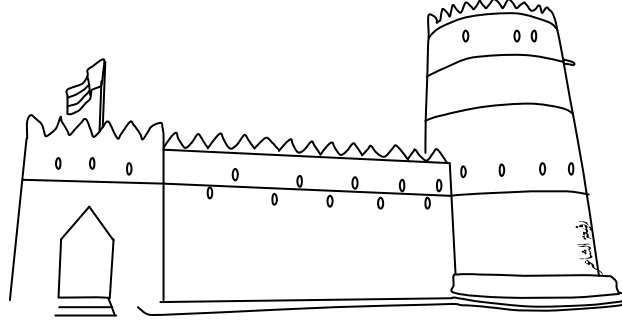
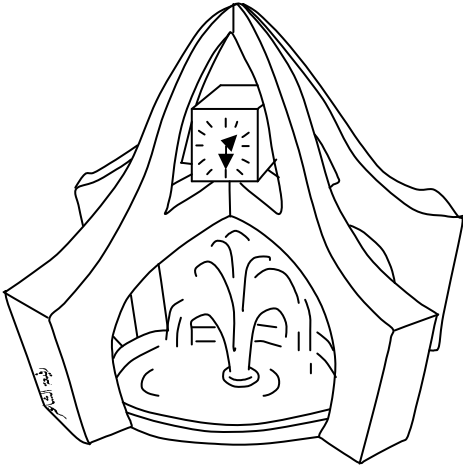

أصل السيارة إلى المطار.

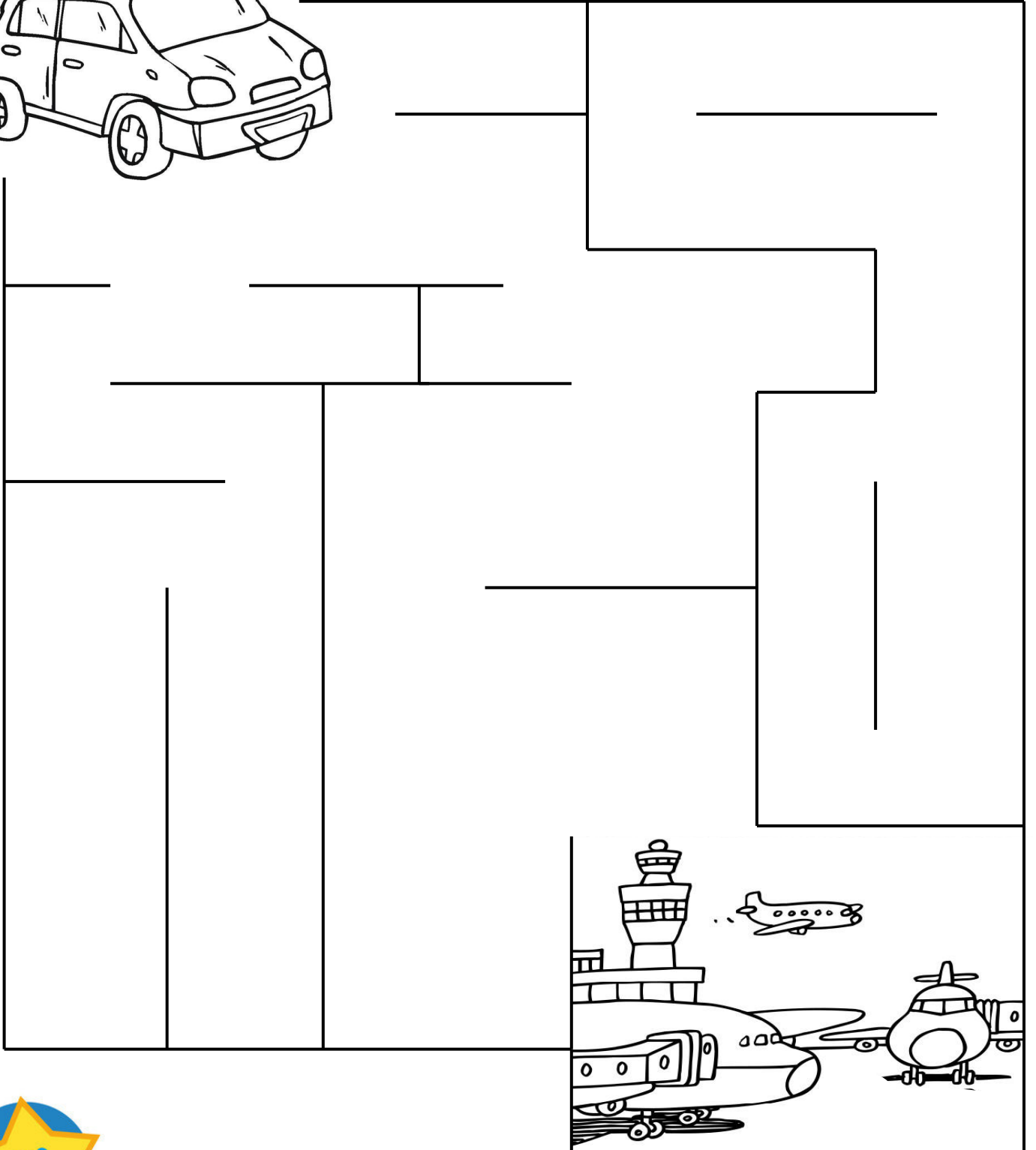
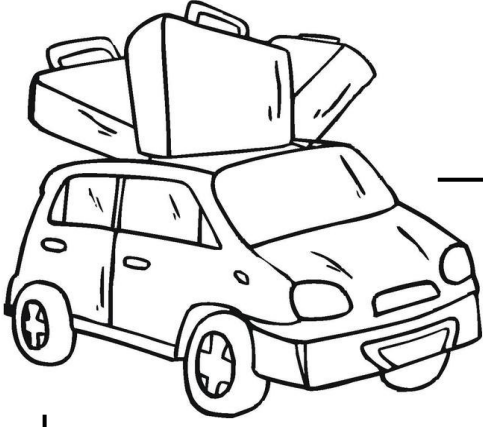

ماذا أحمل معي في حقيبة سفري؟ أحوط إجابتي

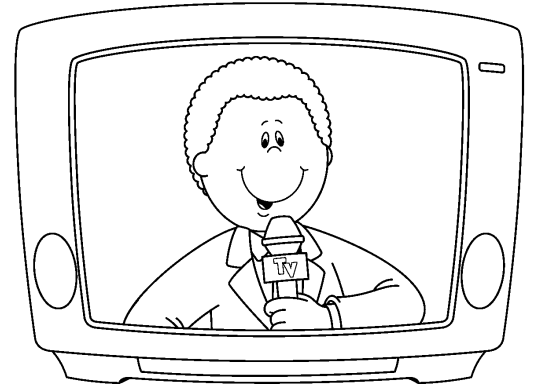
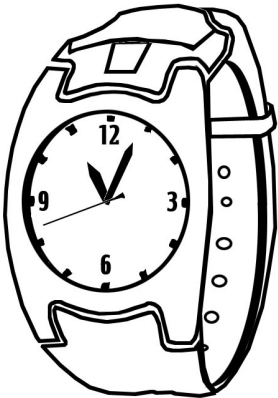
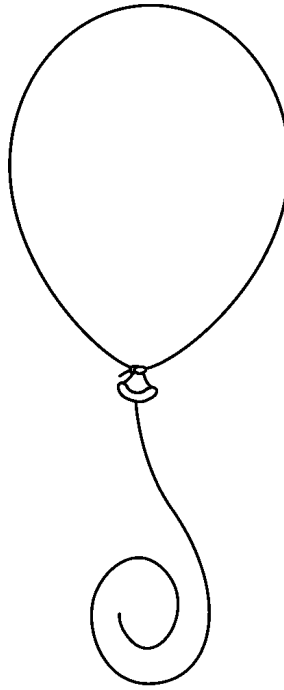
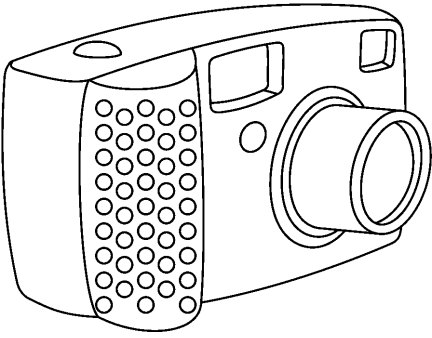
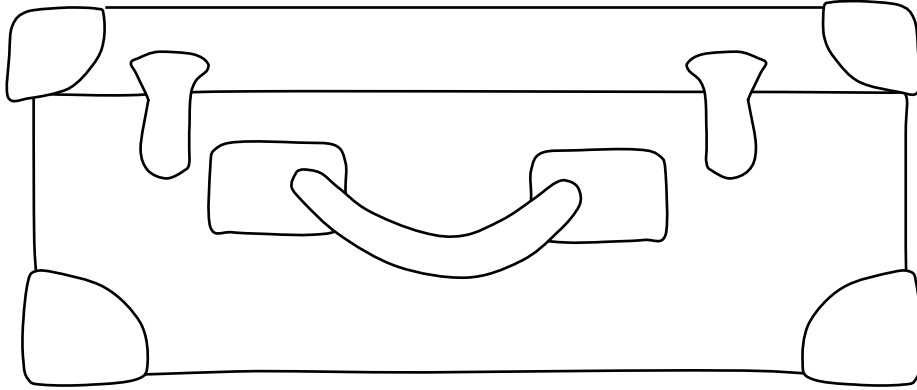

أتعرف على بعض معالم الدول الخليجية ، ألون.

باب البحرين

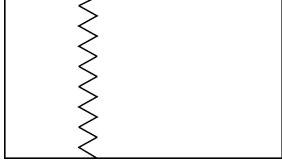

البحرين

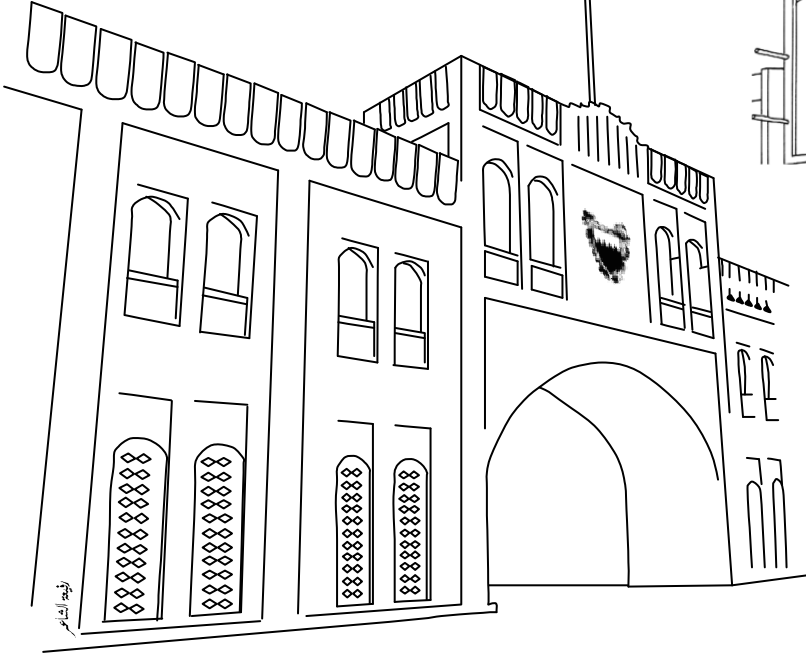

سوق واقف

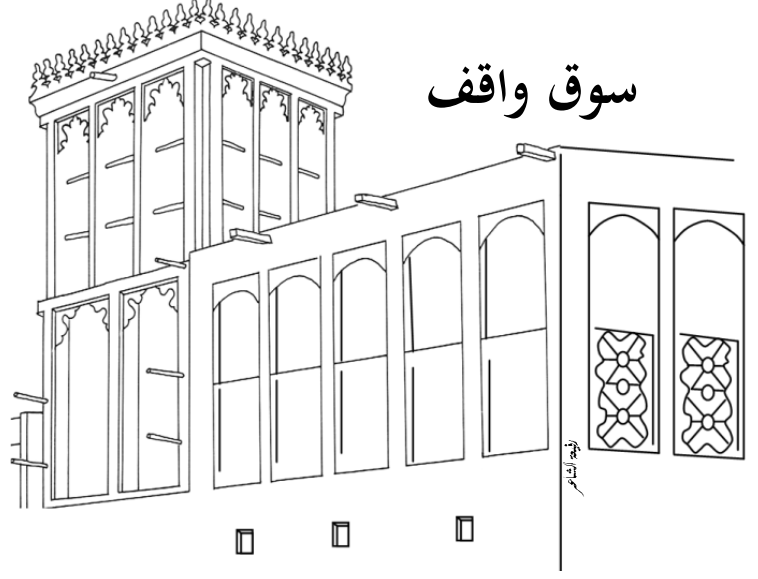

قطر

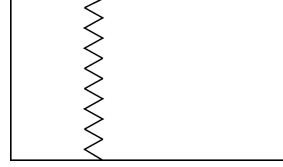

أبراج الكويت

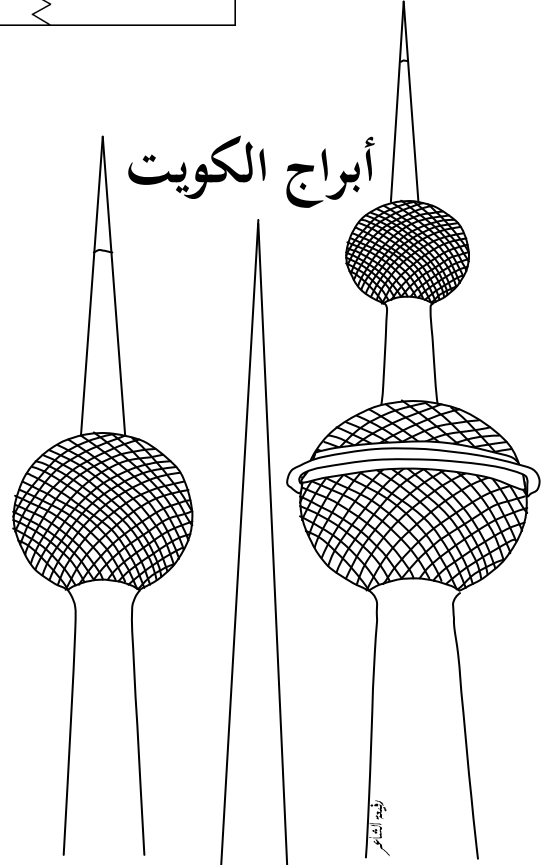

الكويت

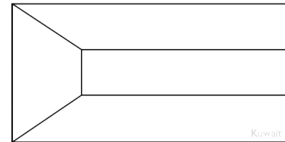

قلعة بهلاء

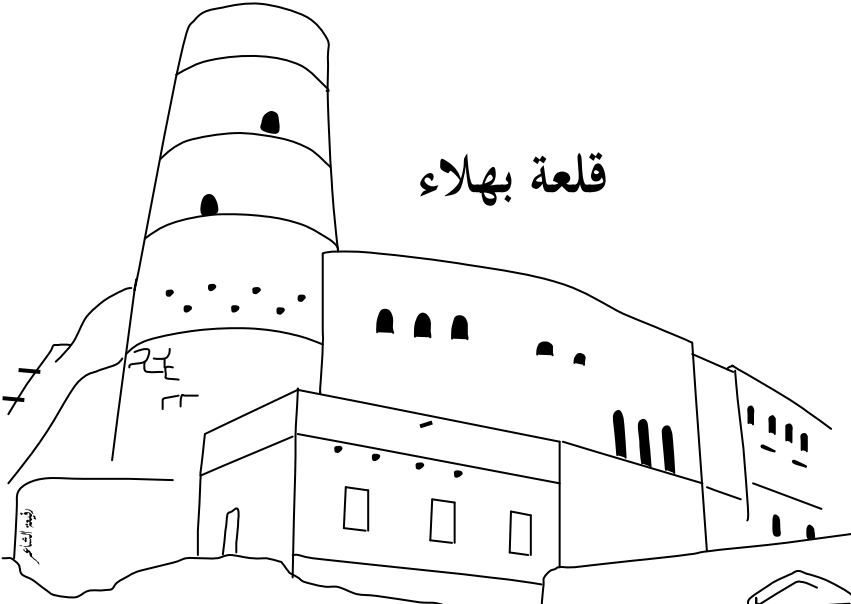

عمان

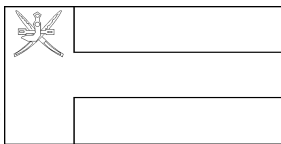

وحدة

الكتاب





القرآن الكريم كتاب الله

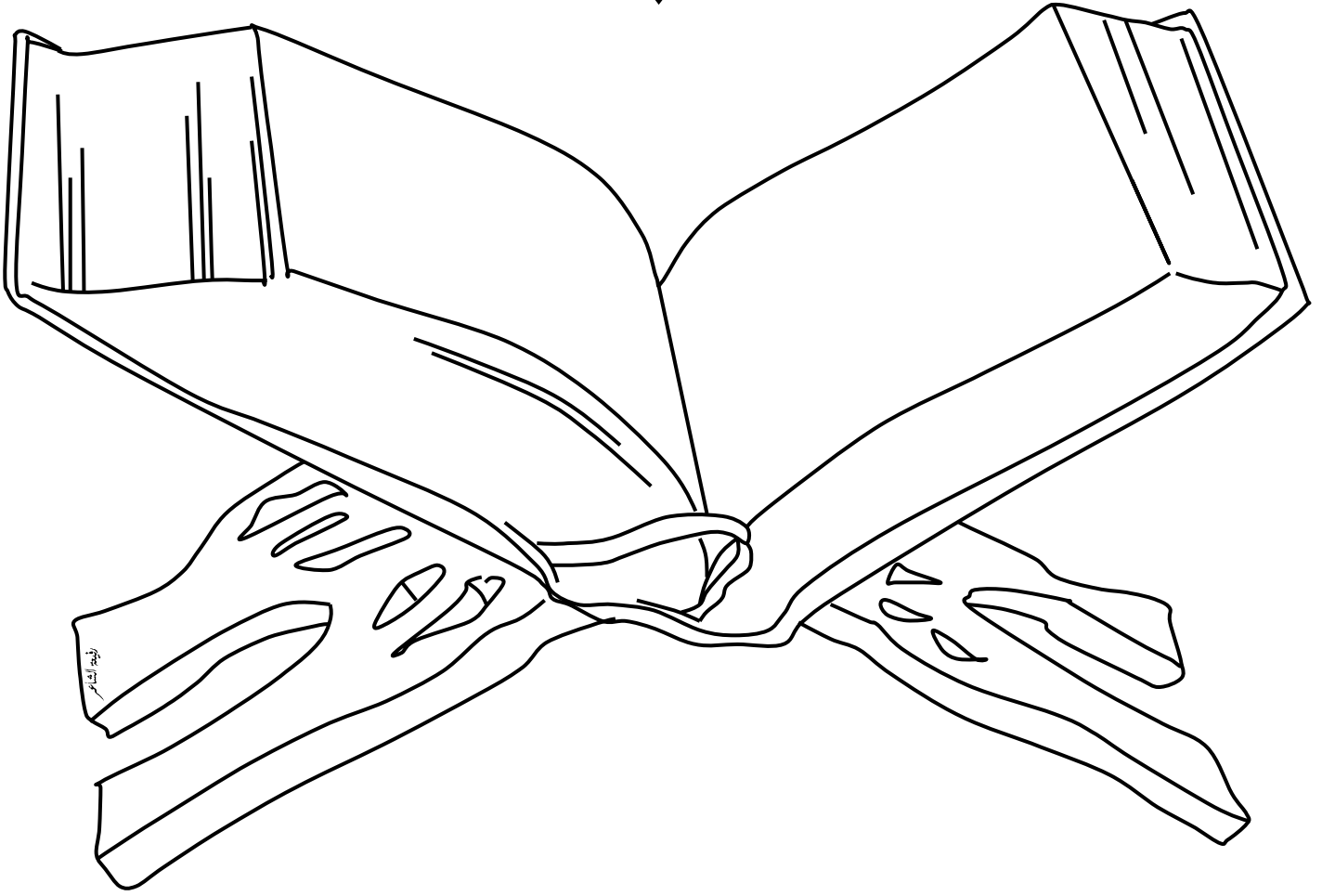

أين أضع كتابي ؟ أصل.



الثلاجة

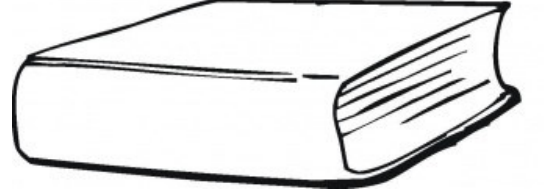

كتابي

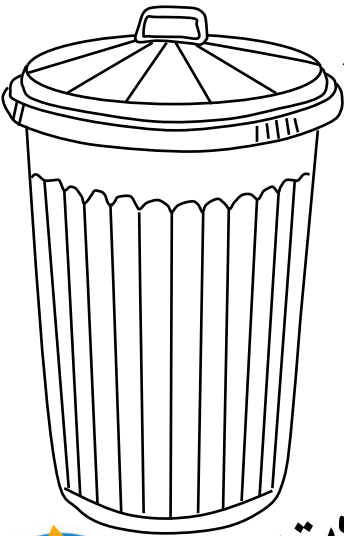

سلة المهملات

المكتبة

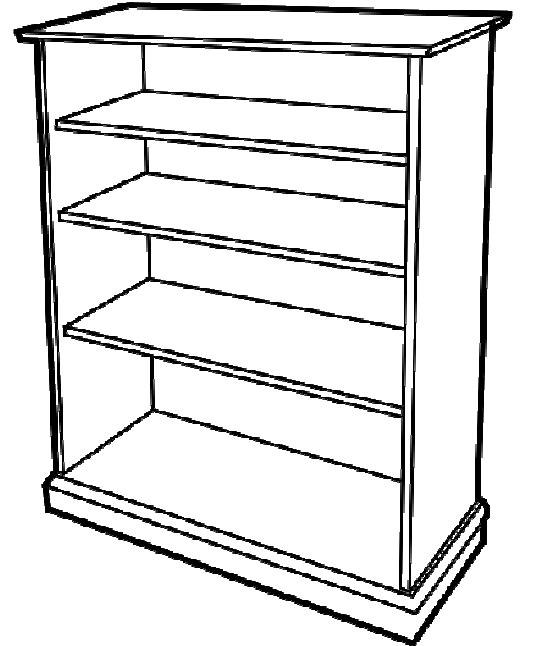

أحبُّ كتابي وأحافظ عليه، ألَوّن الصورة التي تدل على ذلك.

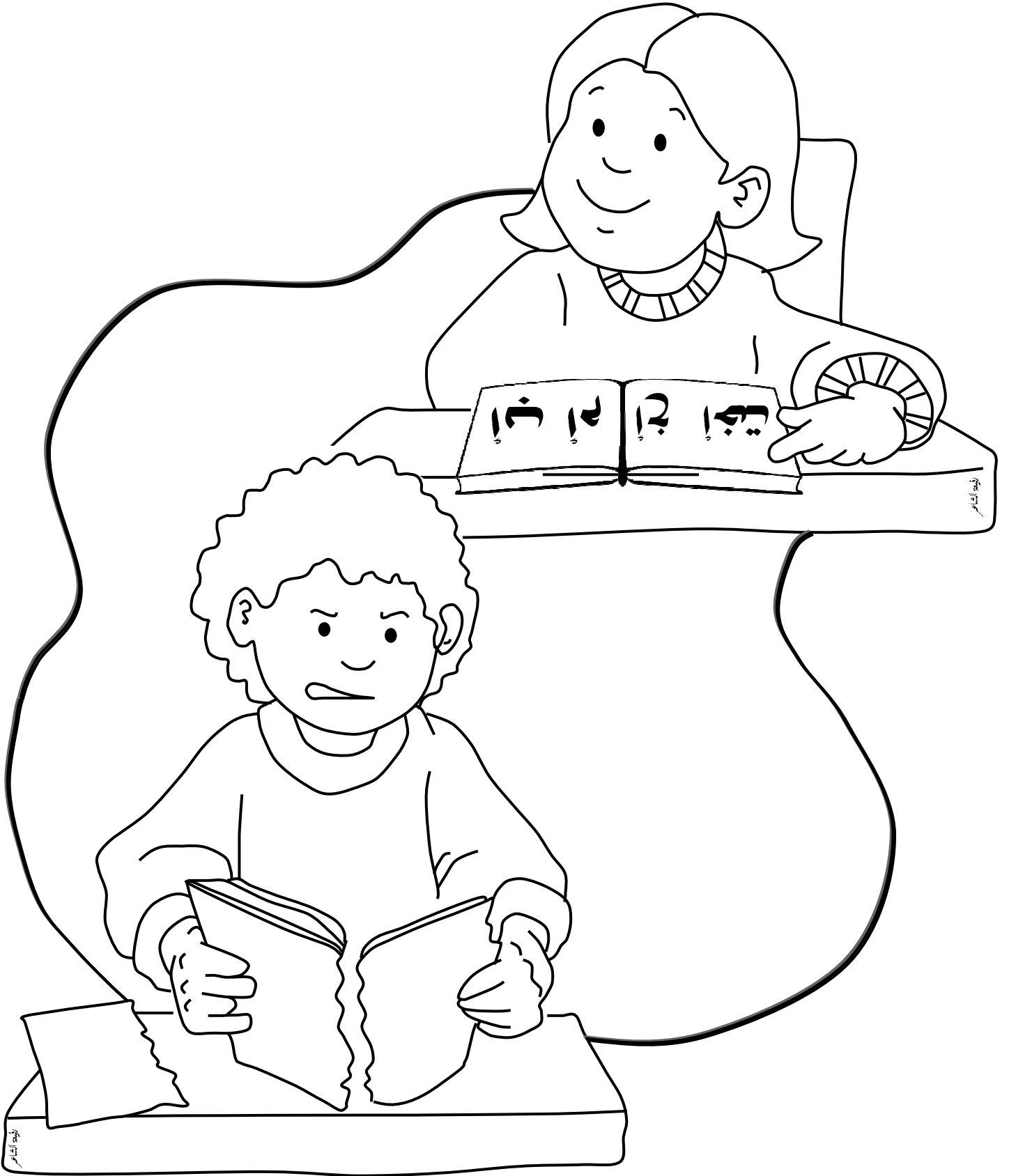

للكتب موضوعات مختلفة، أطبق وأصل.

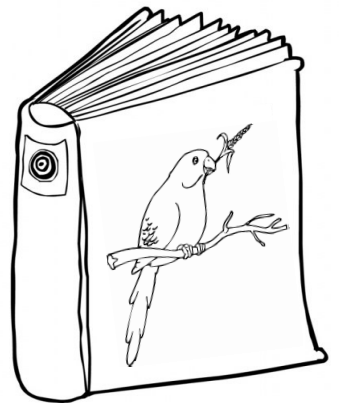
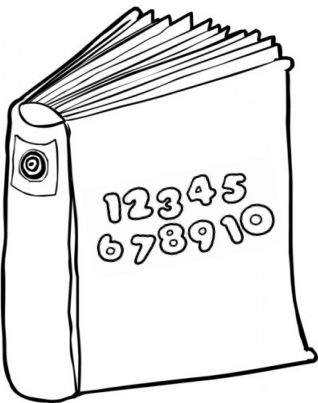
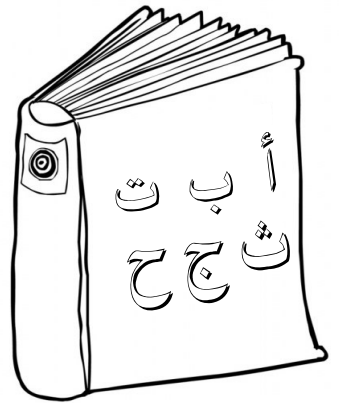
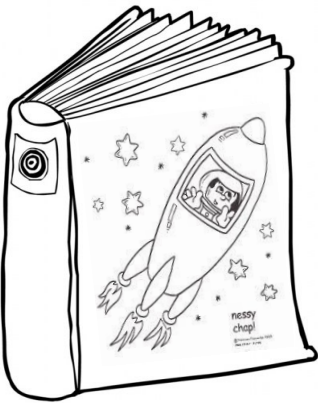
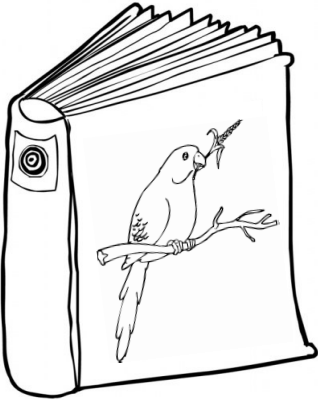
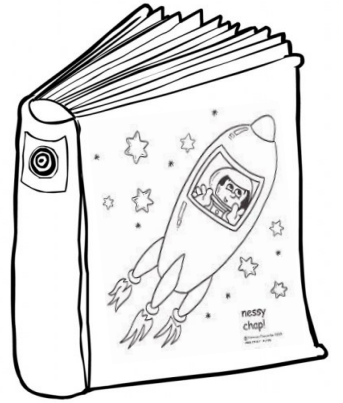
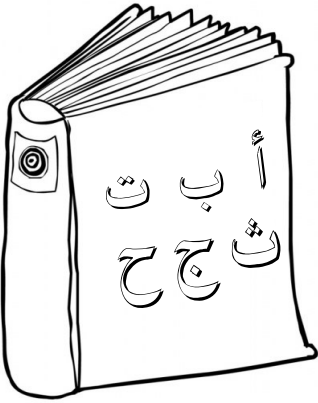

أبحث عن شكل المثلث ألونه.

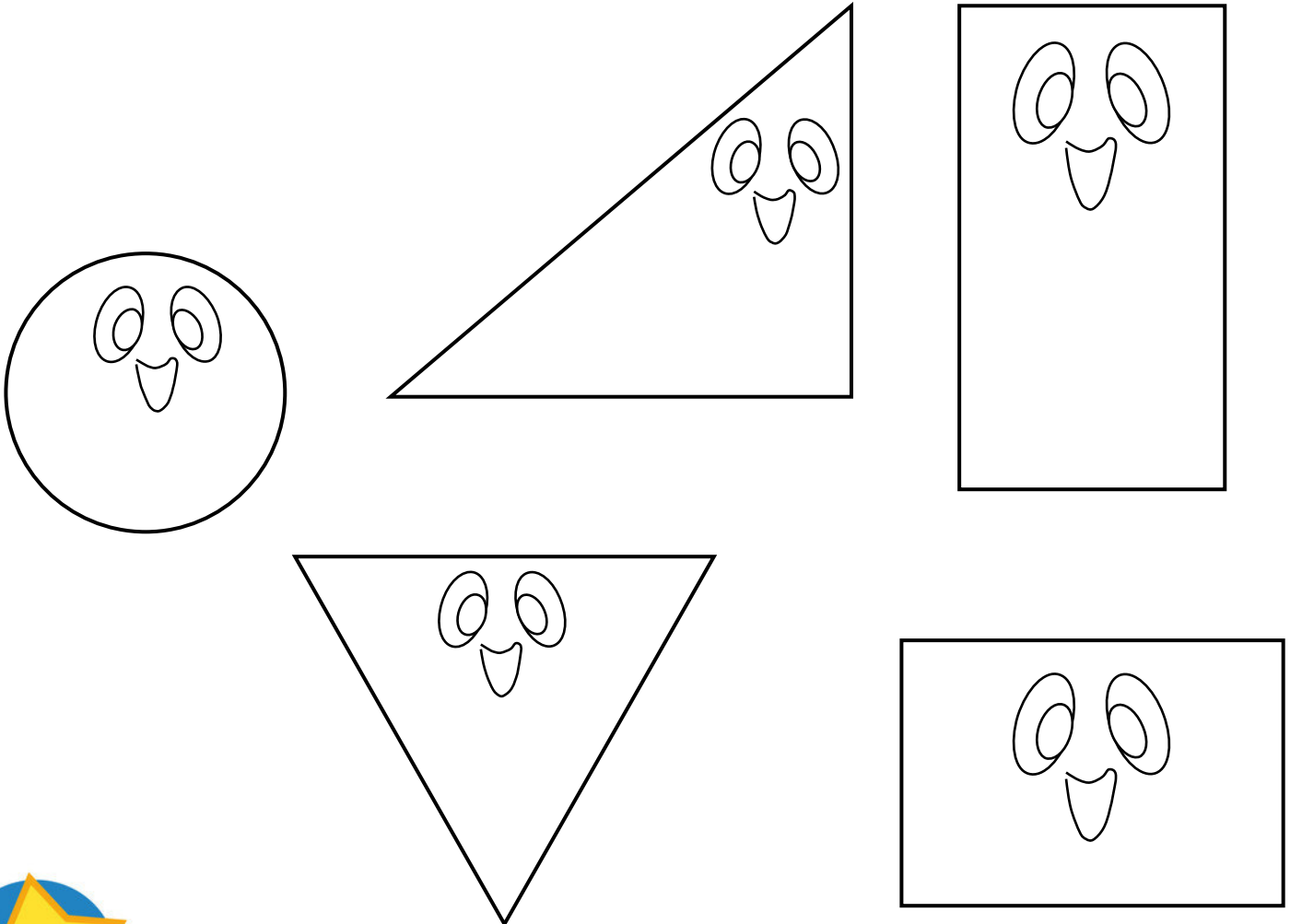
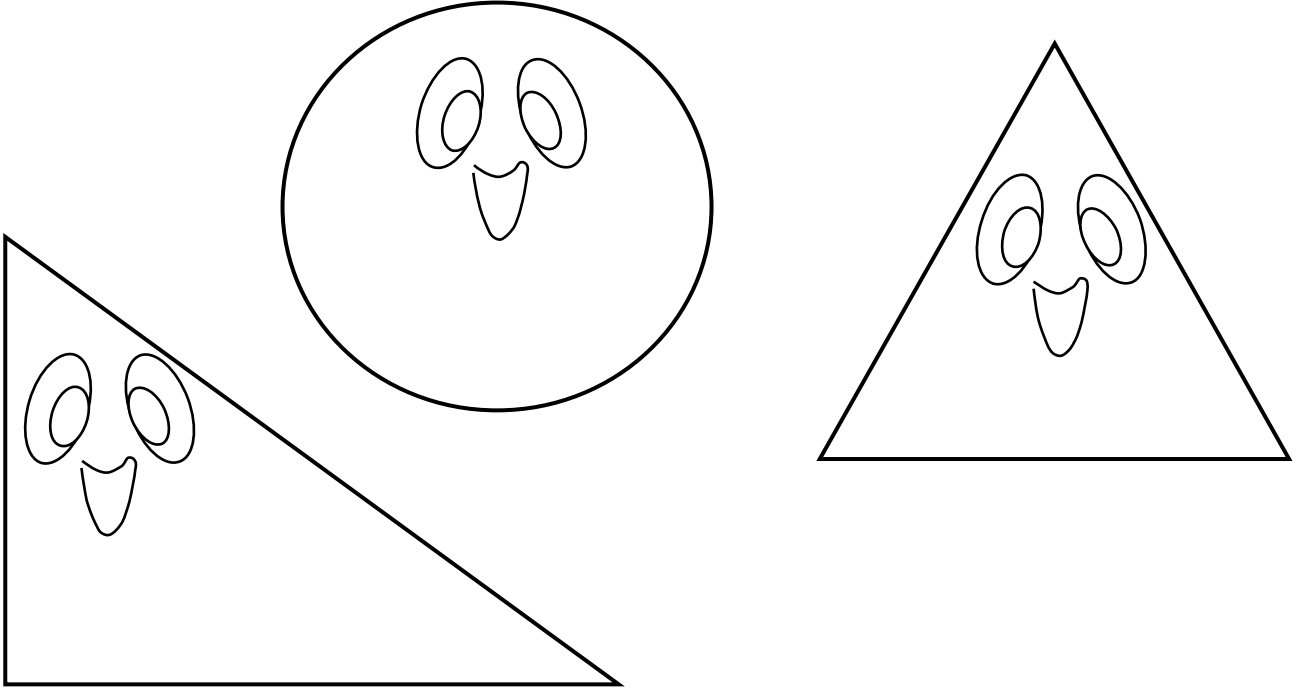



وحدة

البيئة



البيئة

وحداتي

البيئة كل ما يحيط بنا، أحوط مفهوم البيئة.

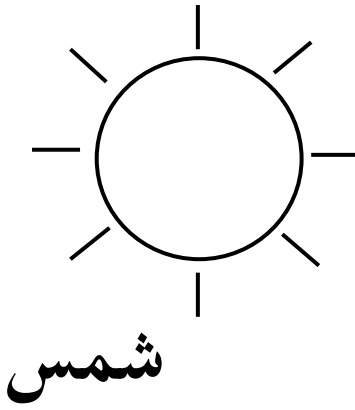

شمس

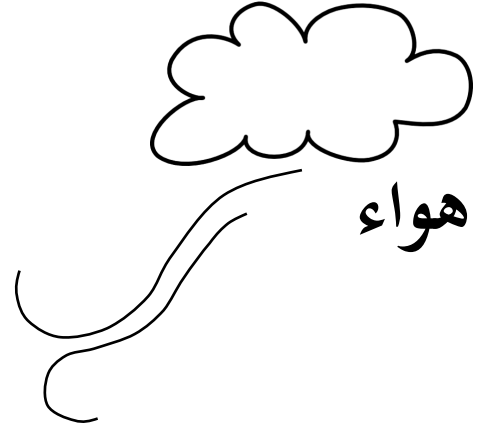

هواء

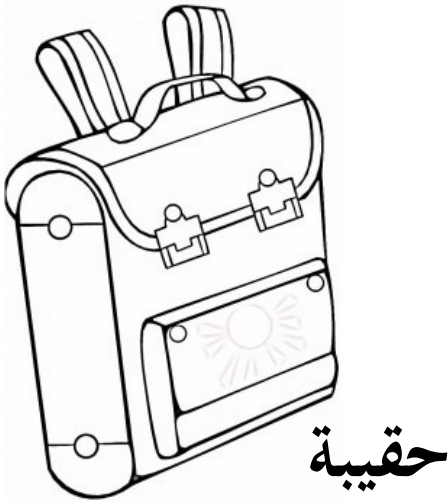

حقية



ماء

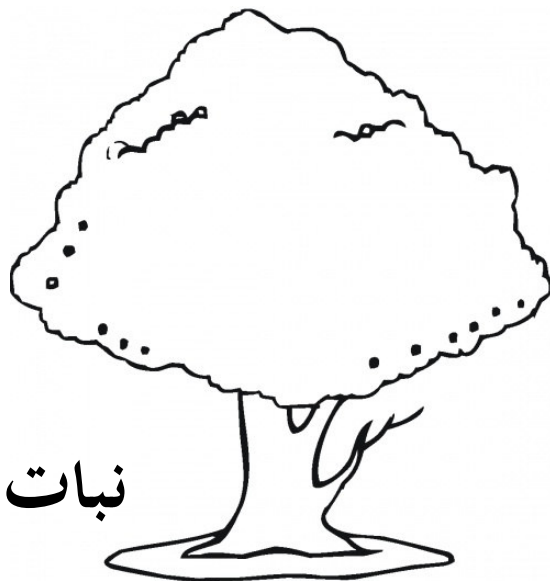

نبات

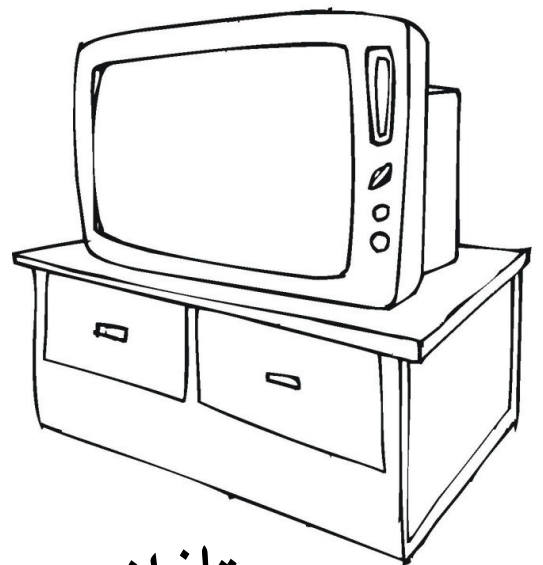

تلفاز



تلوث الهواء، ألون ما يلوث الهواء باللون الأسود.

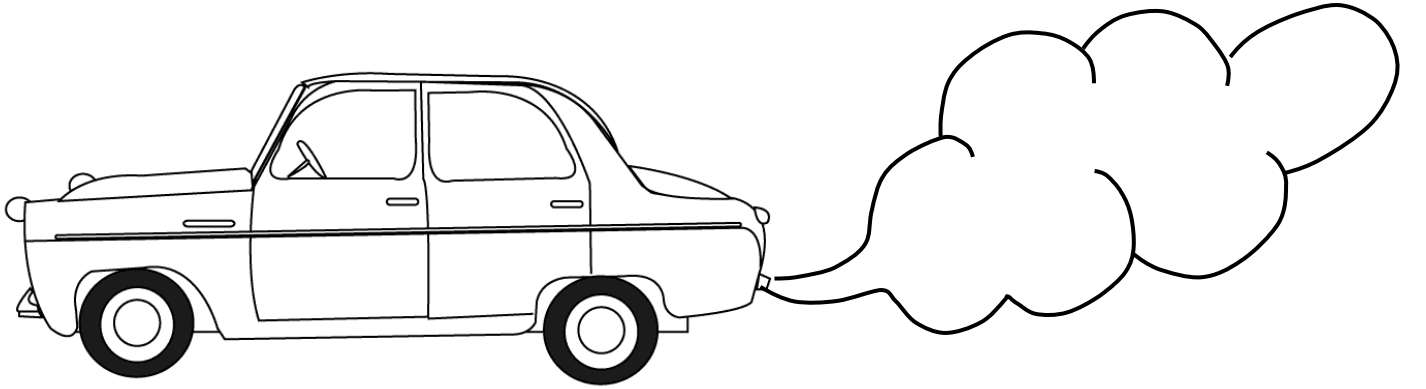
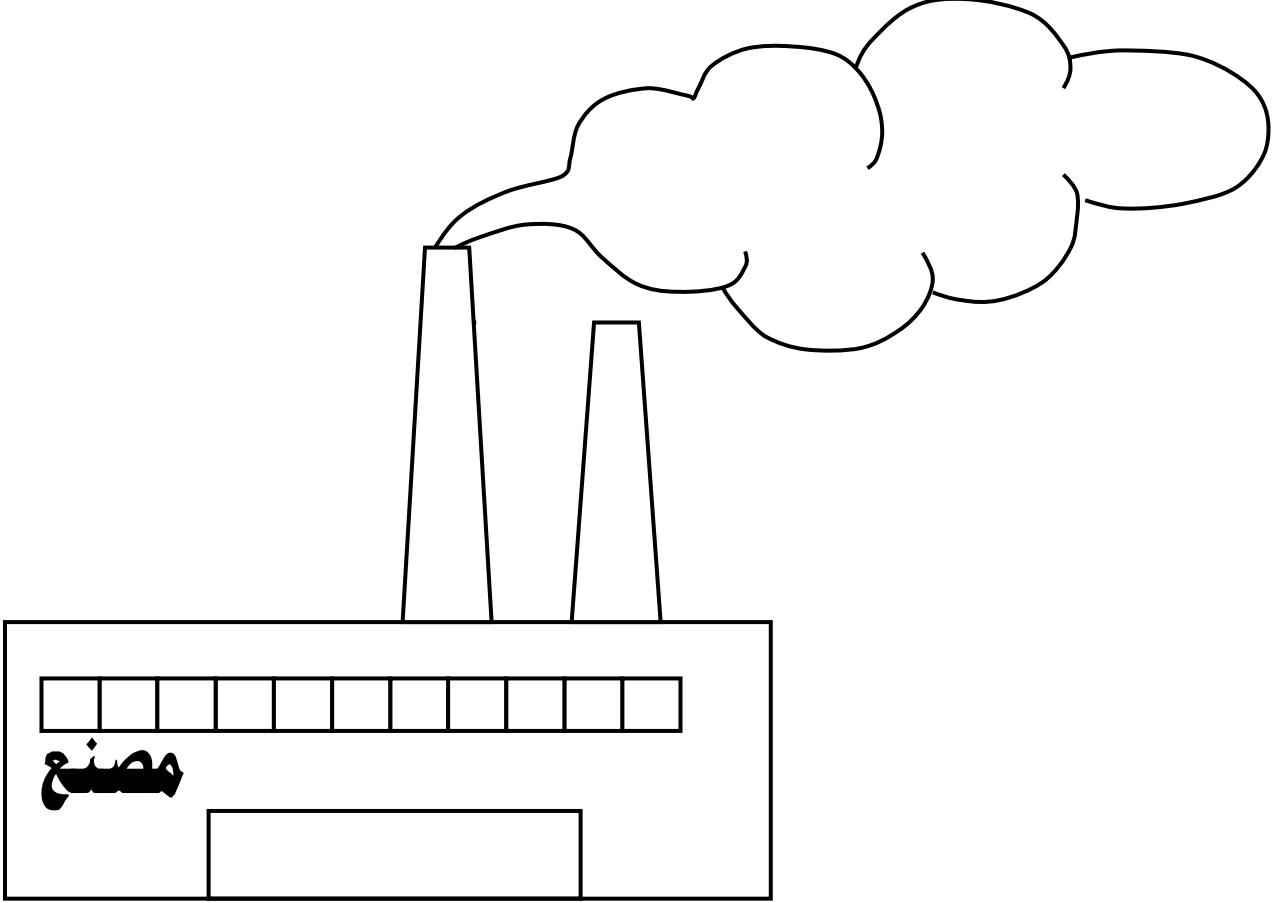

أرسم علامة **X** على السلوك الخاطئ في المحافظة على البيئة.

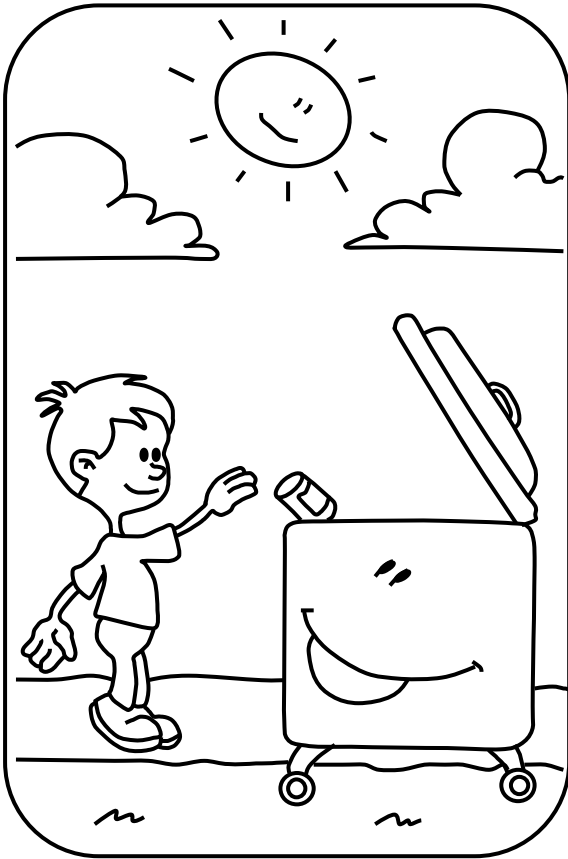
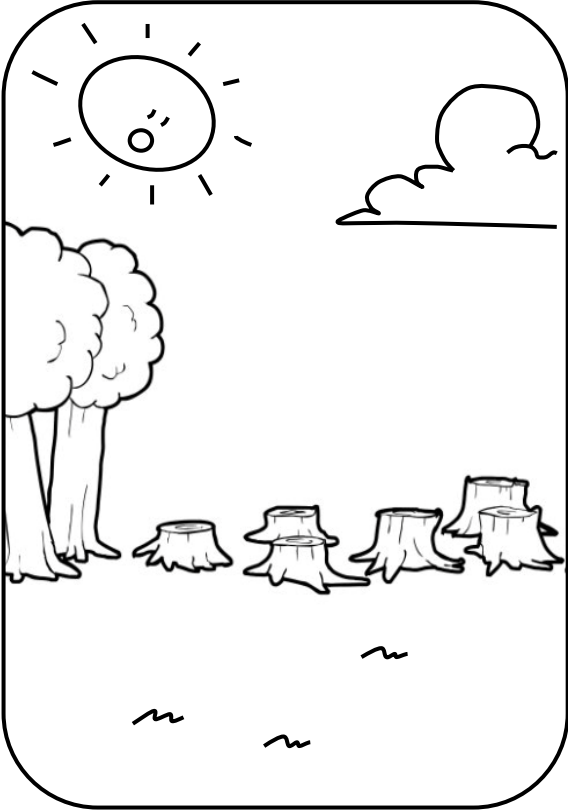

كيف يمكن للطفل أن يحافظ على بيئته؟



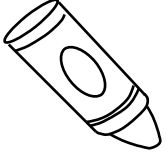

بيئتي نظيفة





وحدة

الفضاء



ماذا يوجد في الفضاء؟ أحوط.

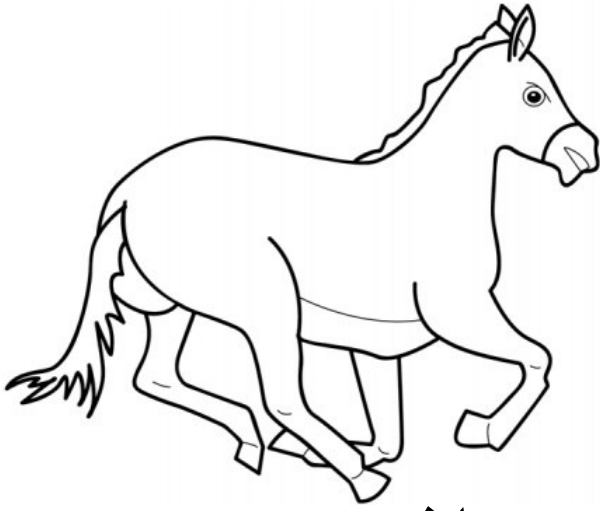

حصان

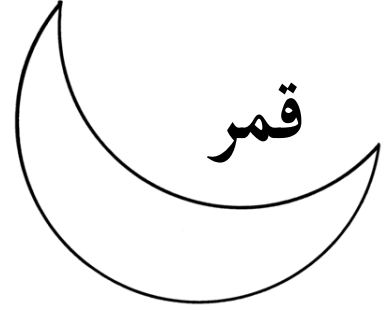

قمر

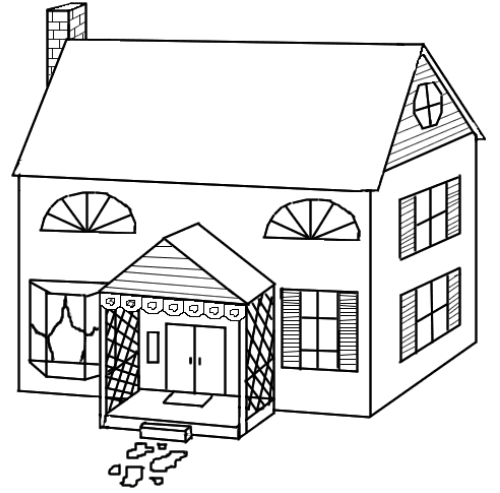

بيت

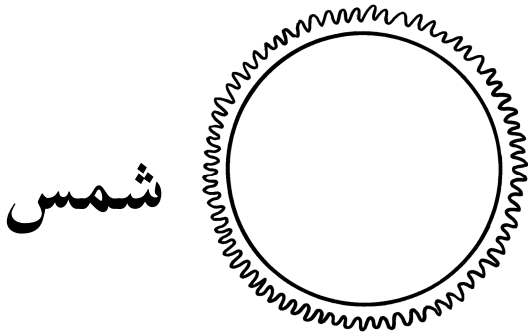

شمس



نجوم

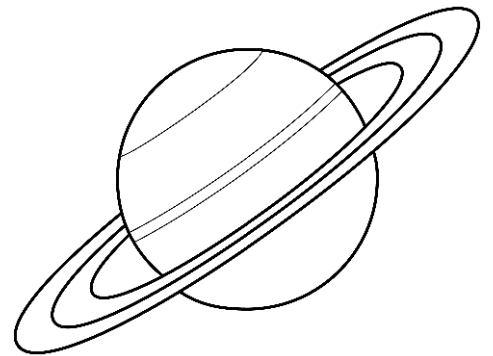

كوكب



الليل والنهار ، أصل.

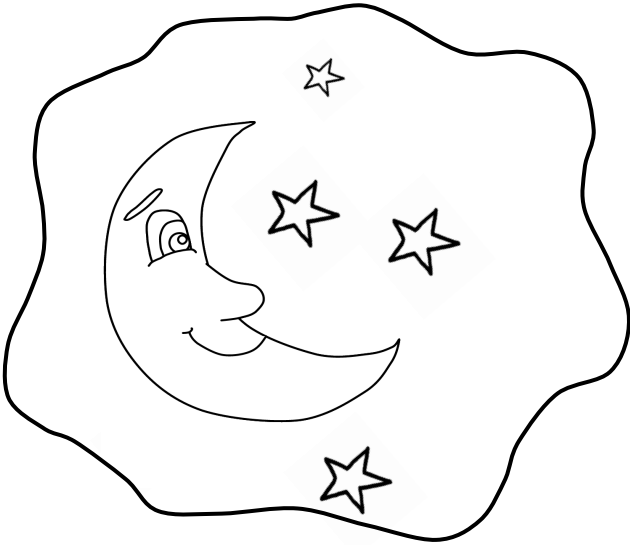
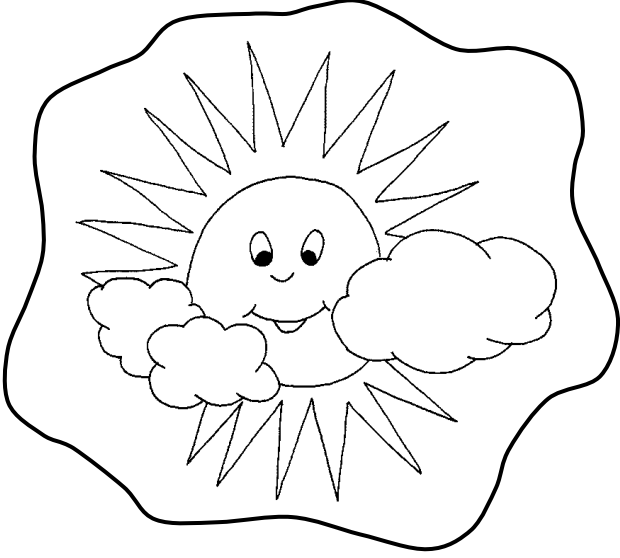

- الشمس والقمر.

اختلاف الليل عن النهار ، قال تعالى " وجعلنا الليل سباتا . وجعلنا النهار معاشا"



أصل رائد الفضاء إلى مركبته الفضائية.

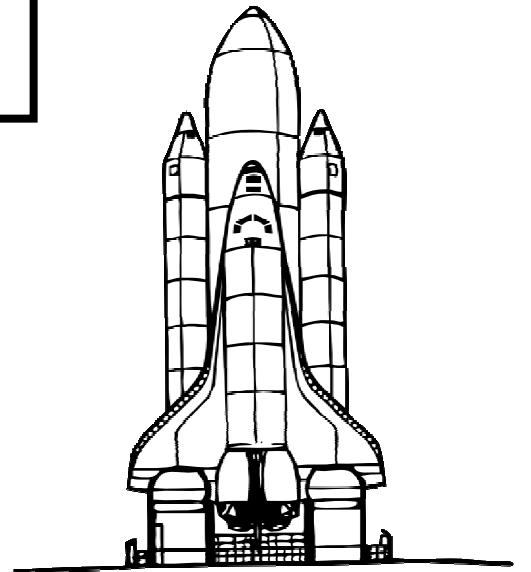
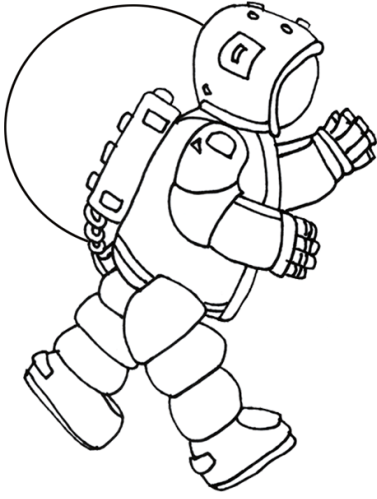

أطابق وأصل.

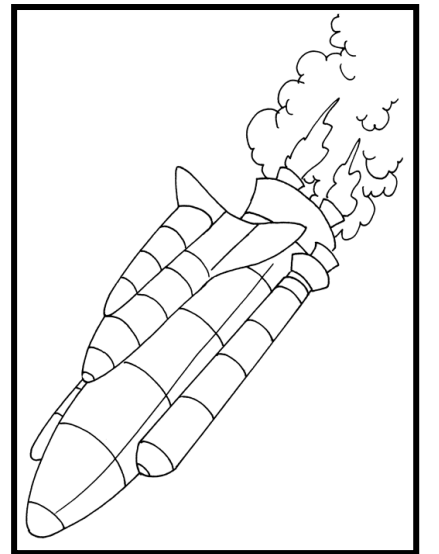
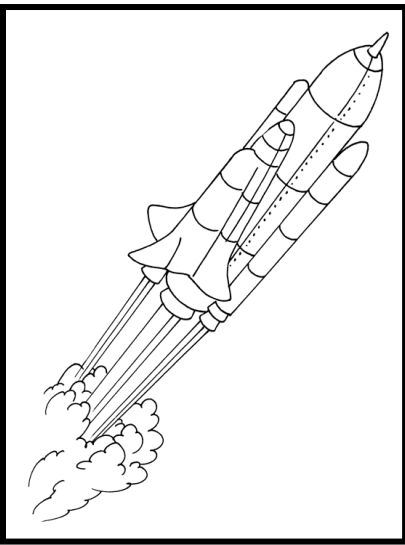
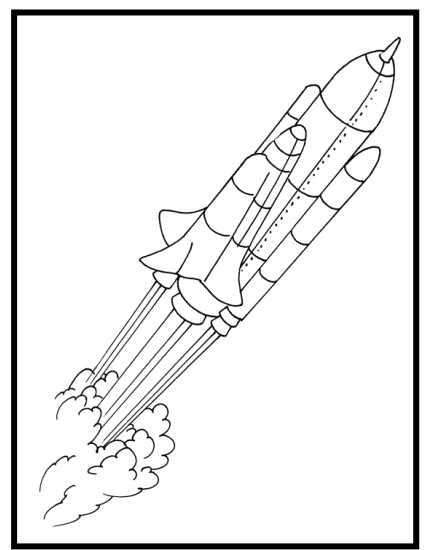
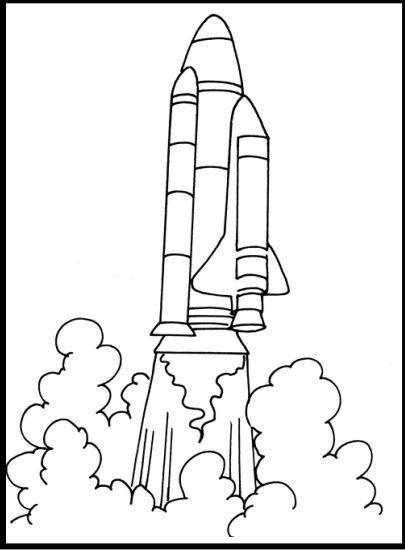
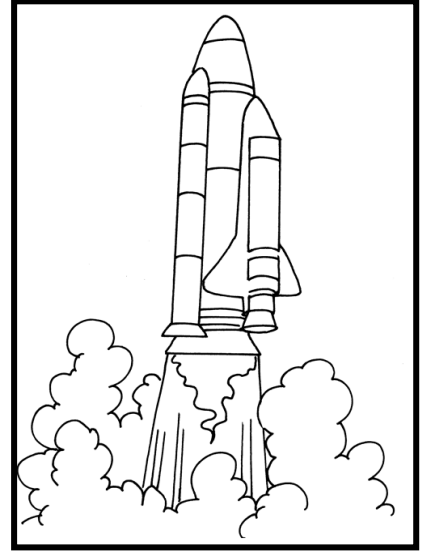
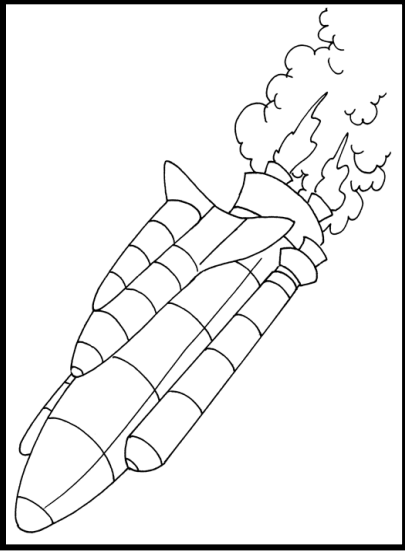

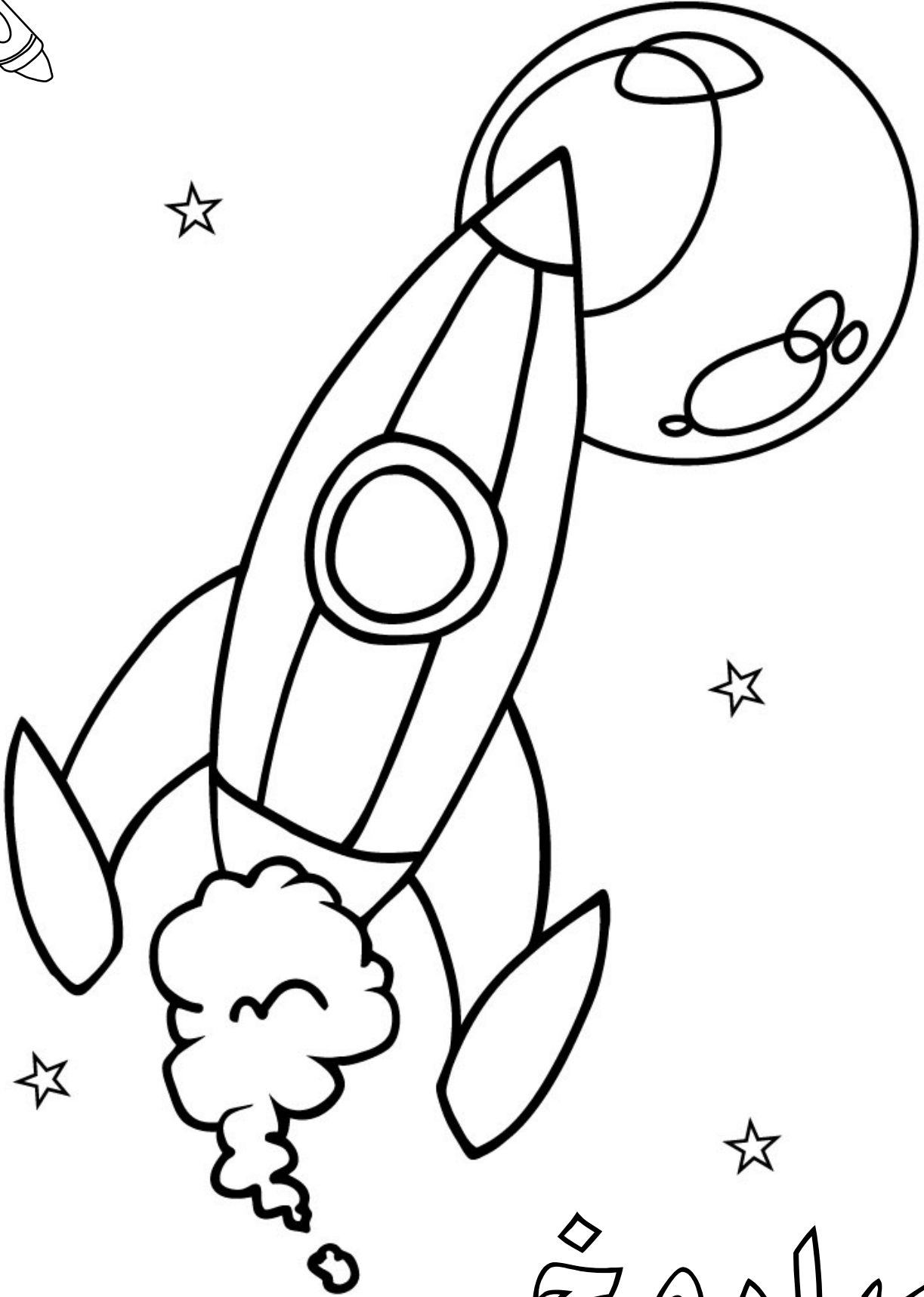
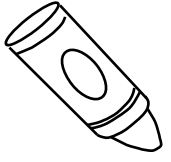

صاروخ



وحدة

مع السلامة



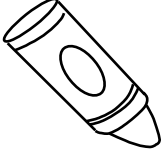

مع السلامة

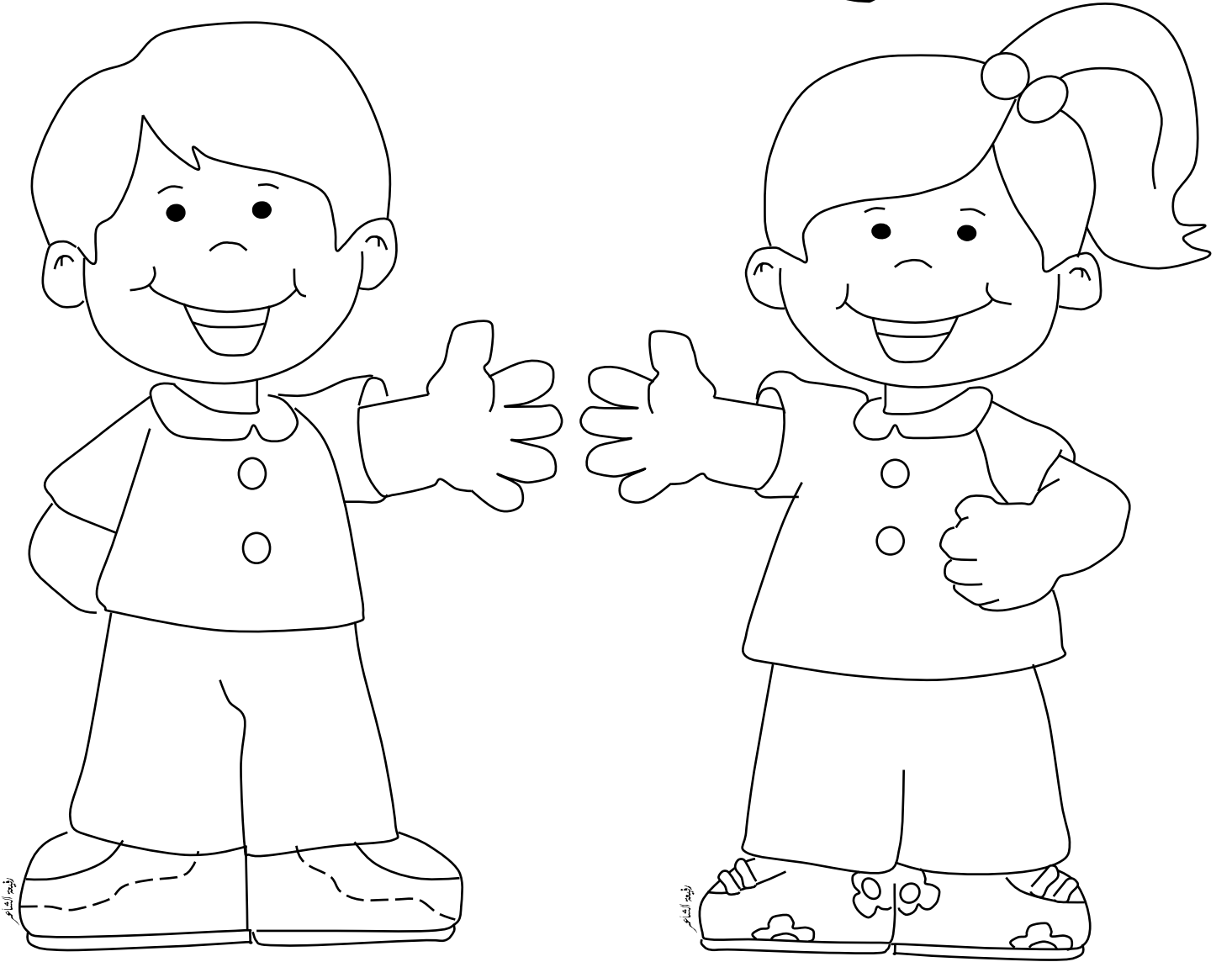



كتاب النشاط قص ولصق



كتاب وحداتي المستوى الثاني



كتاب وحداتي المستوى الأول

الكتب غير مخصصة للبيع
نشر على الموقع الإلكتروني

www.e-portal.ae البوابة التعليمية

لتحميل بقية الكتب ولمشاهدة المواضيع الأخرى المرتبطة
بوحدات رياض الأطفال، ندعوك لزيارة البوابة التعليمية

البوابة التعليمية

WWW.E-PORTAL.AE

